

CHAPTER 6

TELEMETRY EQUIPMENT INSTALLATION

6.1 INTRODUCTION

Telemetry is defined as:

Highly automated communications process by which data are collected from instruments located at remote or inaccessible points and transmitted to receiving equipment for measurement, monitoring, display, and recording. (Encyclopedia Britannica)

The science and technology of automatic measurement and transmission of data by wire, radio, or other means from remote sources, as from space vehicles, to receiving stations for recording and analysis (The American Heritage Dictionary)

The recent progress in electronics and telecommunications has made remote telemetry systems very reliable and cost effective for use in water quality monitoring.

Telemetry can provide the following benefits in a water quality monitoring project:

- Environmental data can be continuously monitored at near real-time.
 - More timely detection and prediction of environmental changes can be achieved.
 - Early detection and warning systems (e.g. alerts) can be developed of where and when a certain condition is favorable to occur (e.g. HAB event)).
 - A reduction of maintenance and project costs can be achieved.
- Reduction of travel and labor costs
 - Reduction of trips to the station to ensure the multiparameter sonde is working correctly. Telemetry allows the user to verify on-line if the multiparameter sonde is working properly.
 - It provides the ability to perform preventive and corrective maintenance, as it can be used to identify when a sensor failed, is close to fail, or requires maintenance.
 - Certain troubleshooting can be performed on-line without the need to send a person to the field.
 - Allows to access remote data instantly; thus, eliminates manual data collection.

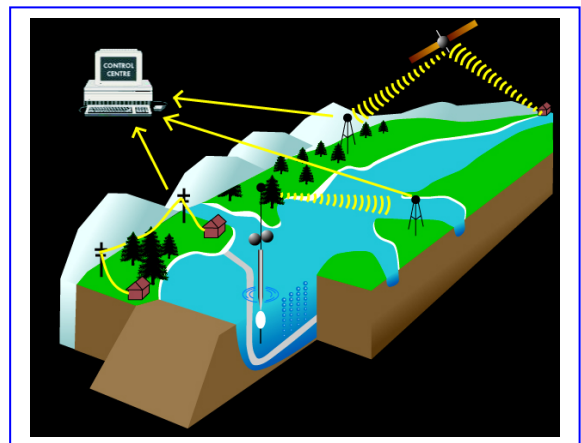

Figure 6.1 Cell phone, radio and satellite telemetry
(Source: Precision Measurement Engineering)

A brief description of the main components of a typical wireless telemetry system and basic guidelines to install the telemetry equipment at the monitoring station are provided in this chapter.

It is not the intention of this chapter to provide a detail description on how to design and implement a telemetry network. The chapter does not describe what requirements and constraints must be taken into account to determine the best wireless communication option capable of meeting the project's needs, neither describes the equipment, operational considerations and costs of the ground receiving station.

In addition, it is not the purpose of this chapter to provide a detail description on how to install a telemetry system (*i.e.* to connect and program the different telemetry equipment). The user must strictly follow the manufacturer's and the service providers' instructions and recommendations in this regard.

Mention of trade names or commercial products does not constitute endorsement or recommendation of their use.

Note: It is recommended to obtain expert help when designing an installing a wireless system.

6.2 TELEMETRY SYSTEM FOR A CONTINUOUS WATER QUALITY MONITORING PROJECT

The telemetry system is basically composed of three subsystems:

1. A data acquisition system: composed of the data collection platforms. A data collection platform (DCP) consists of all the equipment needed in each monitoring station to collect, store, encode and transmits the data: sensors, logger, power supply and the transmitter/antenna system. Each monitoring station with near real-time data transmission capabilities can be considered a data collection platform.
2. A signal transmission system: equipment needed to transmit the data from the DCP to the host or ground station (*e.g.* GOES satellite).
3. A data acquisition, analysis and dissemination system: the host or ground station that receives and manages the data.

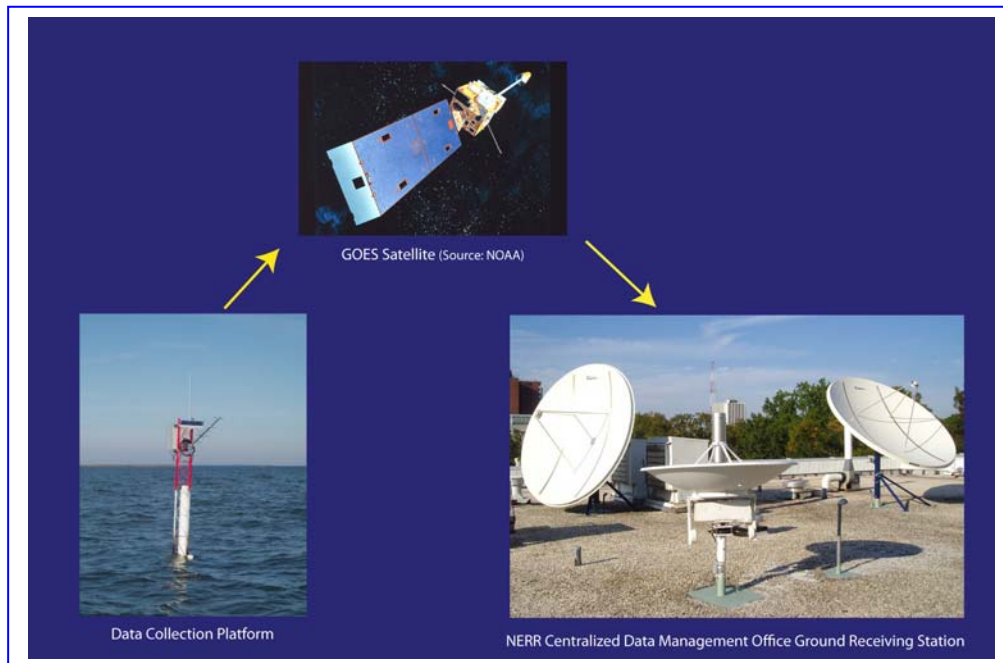

Figure 6.2 Major components of NERR's telemetry system

This section provides a brief description of:

- The most common types of wireless communication options employed in continuous shallow water quality monitoring.
- The data collection platform equipment.

6.2.1 TYPES OF WIRELESS COMMUNICATION

The most common wireless communication options employed in continuous shallow water quality monitoring stations are (South, 2005; Blake, 2007):

VHF/UHF radio telemetry: In the VHF/UHF systems the airtime is free, and the systems are not too expensive to set up (if repeaters are not needed). Typically this type of wireless communication is good if the DCP and ground station are less than 30 miles apart (15 km). Some disadvantages of this type of telemetry are: the system is not easy to install; licensing costs must be incurred and line-of-sight is required.

Cellular telemetry: In areas with strong and reliable cell phone coverage, this can be a good option given the hardware is not too expensive and the system is easy to set up. Some disadvantages are: monthly service fees are required; data quality must be insured given that voice coverage is not the same as data coverage; and coverage can be dropped during peak system utilization.

Spread spectrum telemetry: Spread spectrum telemetry uses specific frequency bands (902 to 928 MHz) that are unlicensed and free. The equipment system is much easier to install than VHF/UHF, but it has a limited communication distance, averaging between 5 and 10 miles. In addition, given that there are free bands it can suffer of band pollution.

Satellite telemetry: Satellite telemetry is the best option:

- For remote monitoring sites
- For locations where there is no cellular coverage.
- For locations that are too far distant for a line of sight radio connection.
- Other telemetry options are not economically feasible (the system cost to provide adequate communication is too high; *i.e.* need to place repeaters).

NOAA operates two Geostationary Operational Environmental Satellites (GOES West and East) that are used only by federal, state and local agencies and government sponsored environmental monitoring applications. Other users may apply for permission to use GOES but there is limited access.

Organizations that can not access GOES will use LEO satellites; for example ORBCOMM or Globalstar. These satellites service have a monthly service fee that would vary with the transmission frequency.

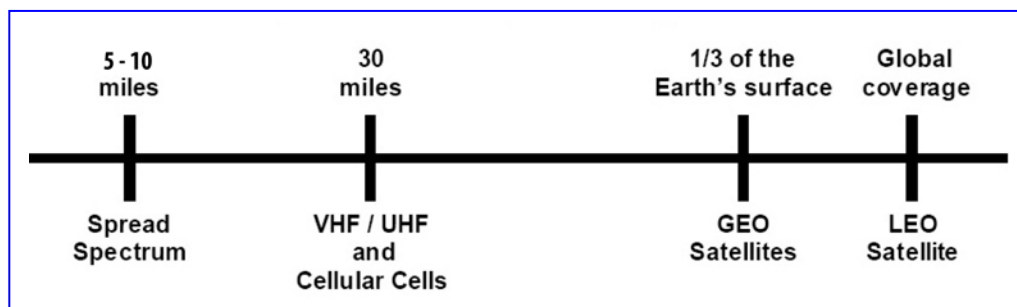
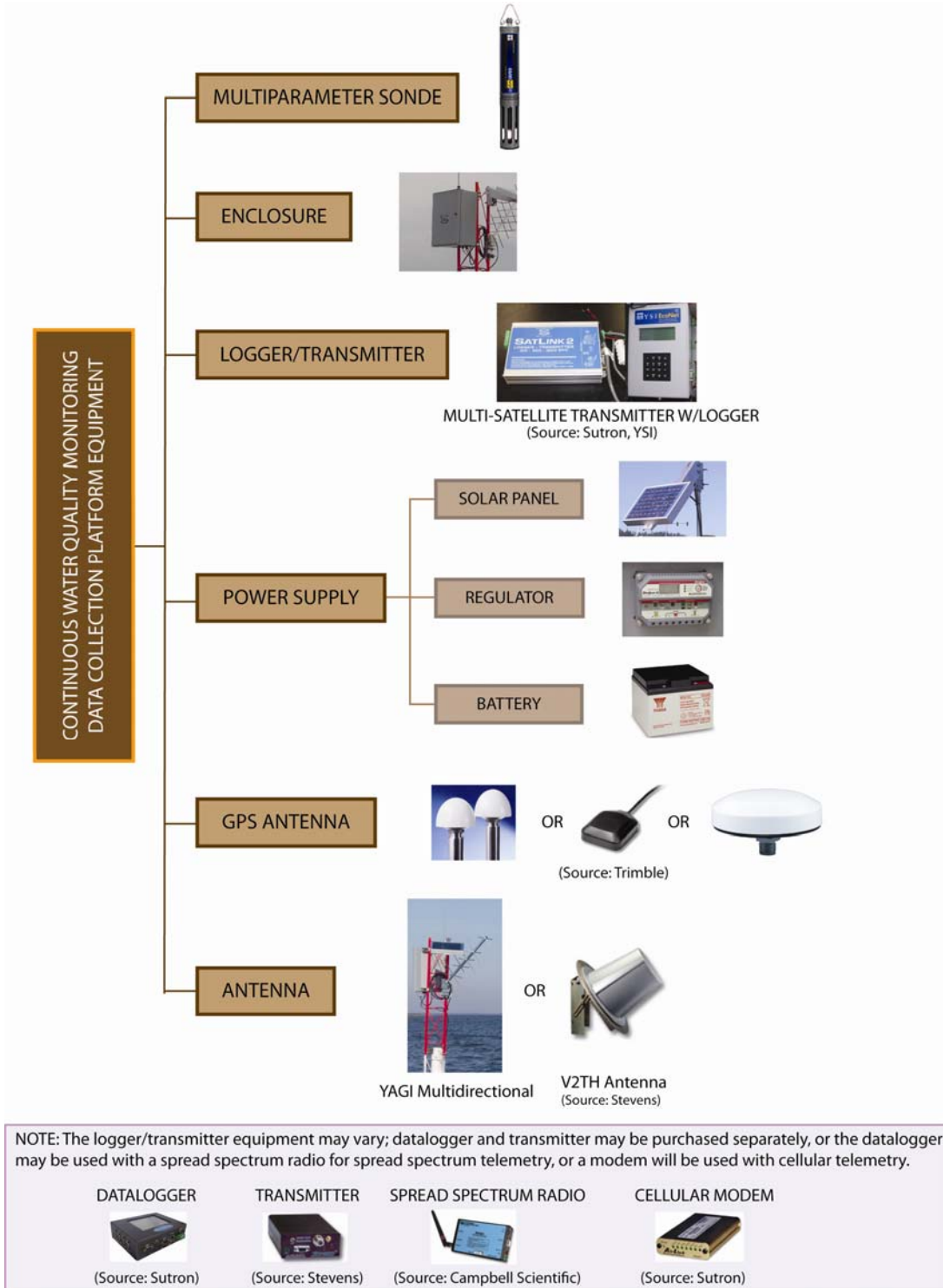

Figure 6.3 Typical maximum DCP-ground station communication ranges (South, 2005)

6.2.2 DATA COLLECTION PLATFORM EQUIPMENT

Telemetry systems are built from commercial off the shelf products. While the different telemetry systems have many common elements, they are each uniquely configured to meet specific application requirements; for example, stand alone data loggers or combined datalogger-transmitter (L-3 Communications).

Following, the basic satellite telemetry equipment is displayed.



6.3 FACTORS FOR CONSIDERATION WHEN DESIGNING A TELEMETRY NETWORK

When planning and designing a telemetry network, certain factors must be taken into account to assure the system will comply with the transmission, cost and operational requirements.

Some factors that must be addressed are:

- Architecture of the system.
- Implementation horizon.
- System requirements in terms of: the location and the number of DCPs, and transmission frequency (short and long-term scenarios).
- System integration and customization requirements.
- System installation requirements.
- Redundant transmission of data (if necessary).
- Cost of network installation, support and maintenance.
- Cost of transmission service.
- Data management requirements (data collection, quality control & quality assurance analysis, data processing, system management, user interface, data dissemination).

If the cost of the ground receiving station is the limiting factor of installing a telemetry network, a possible solution is to use a company that provides the service of collecting the DCP data and delivering it to your organization via the web.

6.4 INSTALLATION GUIDELINES

The material presented in this section is based on the document “**Telemetry Installation Notes**” written by **Jay Poucher**, CDMO Telemetry Coordinator.

Jay Poucher can be contacted at jpoucher@sc.edu.

The purpose of this section is to provide general guidelines for the installation of satellite telemetry equipment in a water quality monitoring platform.

- The installation activities can be subdivided into two parts:
 - a) **Activities that take place before going to the field:** include all the activities of designing the telemetry station, selecting the equipment, discussing the project with the technical representative, designing the monitoring platform or reviewing existing one to determine if modifications are needed, *etc.*
 - b) **Activities that take place on-site:** include all the activities of installation and set-up of the equipment, inspection and verification.
- The installation activities, and the equipment and field tools requirements will vary depending on:
 - The type of telemetry system to be installed.
 - The type of monitoring platform.
 - The monitoring site location.
- It is recommended to obtain expert help (*e.g.* from the telemetry equipment representative or from a known organization that has a similar telemetry network installed) for advice and/or to discuss installation requirements and possibly request his/her presence during the first installation.

Note: If another type of wireless communication is employed, *e.g.* cellular, the same installation guidelines can be used. The basic equipment (enclosure, solar panel, and grounding system) will be the same, the only difference would be the type of transmitter and associated antennas (*e.g.* instead of using a YAGI, a high gain antenna-cellular frequency, will be used).

6.4.1 Pre-Installation Activities

Due to the wide range of telemetry equipment and monitoring site characteristics, most telemetry system would require custom designs and best engineering judgment in order to obtain the best system performance.

Even though the great variability in telemetry systems designs, some pre-installation activities are common to all systems. Among them, it is worth to mention:

- Power equipment and antenna considerations.
- Monitoring platforms requirements.
- Development of an installation plan.

6.4.1.1 Power Equipment Considerations

→ Power Consumption of the System

The power consumption of a telemetry system is the sum of the average current drains of all the different equipments (*e.g.* datalogger, multiparameter sonde and peripheral equipments).

To calculate the power consumption, the percentage of time the equipments spent in active state (performing measurements, processing/sotring data) versus the time they spent in a quiescent state must be determined (Campbell Scientific, Power Supplies).

→ Battery Considerations

The battery must have the capacity to power the different equipment during the whole deployment cycle. If the battery is charged with a solar panel, the battery is required to have a reserve source of energy sufficient to operate the particular installation, with the highest power consumption during the night and periods of low sun light.

The energy for insolation (incoming solar radiation or energy from the sun) varies with the latitude and the month (*e.g.* the isolation levels in kWh/m²/day for Boston during Dec&Jan&Feb is 1.83 and 5.32 for Jun&Jul&Aug; while Miami receives 3.93 and 6.21 respectively) (NASA).

The battery must have certain reserve time to accommodate periods of low levels of isolation. Recommended reserve times based on latitude are shown in Table 6.1

Latitude of monitoring site	Recommended reserve time
0° to 30° (N or S)	144 to 168 hr
30° to 50° (N or S)	288 to 336 hr
50° to 60° (N or S)	732 hr
Polar regions	8,760 hr

Table 6.1 Recommended reserve time based on latitude
(Source: Campbell Scientific, Power Supplies)

The energy stored in a battery is known as “battery capacity”. The common measure of battery capacity is the number of amp-hours that can be removed from a battery at a specified discharge rate at the nominal voltage of the battery (Photovoltaic Education Network).

To calculate the system’s required battery capacity, a simple equation can be used (Campbell Scientific, Power Supplies):

$$\text{Required battery capacity} = (\text{system's current drain}) \times (\text{reserve time}) / 0.8$$

- The 0.8 value is to assume worst case conditions (limit the battery depth of discharge to 80%).

For polar regions the equation would be:

$$\text{Required battery capacity} = 2 \times (\text{system's current drain}) \times (\text{reserve time})$$

Note:

- It is recommended to use sealed lead batteries.
- For extremely cold temperatures, Campbell Scientific recommends using the Cyclon battery manufactured by Hawker Energy Products.
- Daily Amp-Hour Usage Calculator can be found at:
<http://www.bigfrogmountain.com/calculators/dailyamphourusage.htm>

→ **Solar Panel Considerations**

Required Solar Panel Current

The solar panel converts sunlight into direct current. The current the solar panel must provide (in terms of battery capacity) can be determined using the following equations (Campbell Scientific, Power Supplies):

$$\text{Solar panel current} > ((\text{system amp-hr/day}) \times 1.2) / (\text{Hours of light})$$

- 1.2 accounts for solar panel system loss.
- Hours of light: the number of hours in the day the sky is clear enough for the solar panel to source current (use the worst case condition, *i.e.* winter).

$$\text{For polar regions solar panel current} > (\text{system amp-hr/day}) \times 2$$

Solar radiation data can be obtained from National Renewable Energy Lab (NERL).

- **Solar radiation for 239 sites in the US** with extensive weather records can be found in the publication “Solar Radiation Data Manual for Flat-Plate and Concentrating Collectors” <http://rredc.nrel.gov/solar/pubs/redbook/>
- **U.S. Solar Radiation Resource Maps:** 30-year average for a particular month can be found at http://rredc.nrel.gov/solar/old_data/nsrdb/redbook/atlas/Table.html
- **Solar maps** can be found at <http://www.nrel.gov/gis/solar.html>

- For parts of the world with little solar radiation data, NREL created a crude global data set using data inferred from satellites.
- In addition, world radiation data can be found in World Meteorological Organization at <http://wrdc-mgo.nrel.gov/>

Solar Panel Orientation

Solar panels can be mounted at a fixed azimuth and tilt angle or on frames that allow for orientation adjustment.

Solar panels should face true, due or geographic south in the Northern Hemisphere and true, due or geographic north in the Southern Hemisphere.

Note: Geographic south is defined as azimuth=0°. Angles to the east of due south are negative, with due east having azimuth=-90°. Angles to the west of due south are positive, with due west having an azimuth=90° (Solar Plots Info).

Fixed orientation: orient solar panel to the geographic south (not magnetic south) in the Northern Hemisphere. Suggested tilt angles (referenced to the horizontal plane) are shown in Table 6.2. These tilt angles maximize output for winter. Even though optimization summer angles are different, the extra isolation that occurs during summer makes up for the less than optimum angle (Stein, 2008).

Site Latitude (°)	Tilt Angle above horizontal
0 – 10	10 degrees
11 – 20	Latitude + 5 degrees
21 – 45	Latitude + 10 degrees
46 – 65	Latitude + 15 degrees
> 65	80 degrees

Table 6.2 Suggested tilt angles
(Source: Campbell Scientific, Power Supplies)

Adjustable orientation: orient solar panel to the geographic south (not magnetic south). Suggested tilt angles above horizontal are given by the following equations (Landau, 2008):

- Tilt angle (winter) = (Latitude x 0.9) + 29°
- Tilt angle (spring and autumn) = Latitude - 2.5°
- Tilt angle (summer) = (winter angle) - 52.5°

Note: Generally, it is not worthy the effort to shift the solar panel orientation more than twice a year: once in the spring and once in the fall (Stein, 2008).

Bird Spikes

In most coastal environments, and particularly at off-shore stations, birds can be a problem, especially bird droppings. If this is the case at a particular monitoring site, bird spikes must be employed.

6.4.1.2 Monitoring Platform

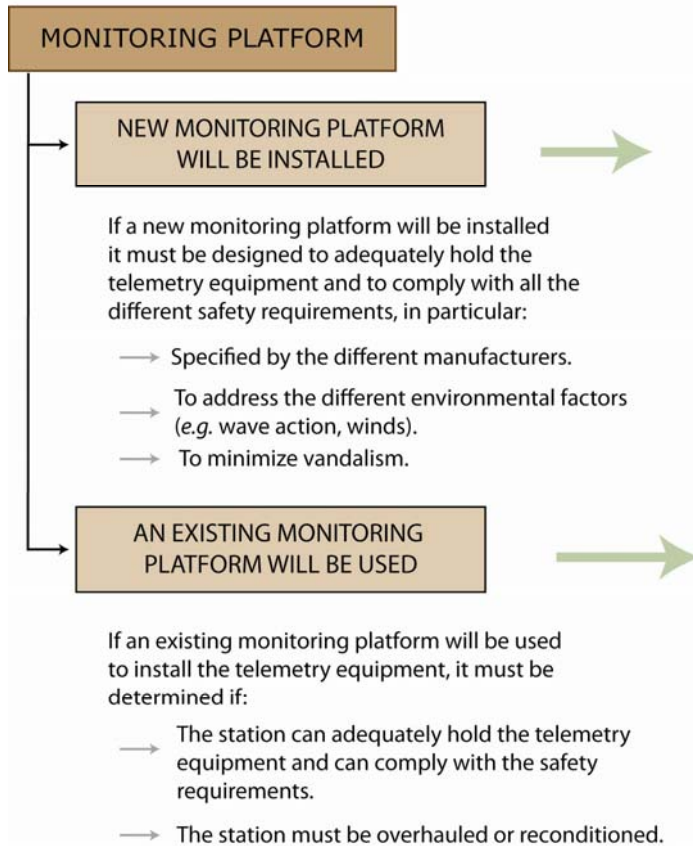

If local regulations prohibit the installation of an offshore permanent monitoring station or it is not possible to modify the existing platform; the design team must consider if it is possible to set the telemetry station on-shore.

This option requires the utilization of a long field cable to connect the multiparameter sonde to the remote location.

Possible Hardware Configuration Scheme for Telemetry Installation

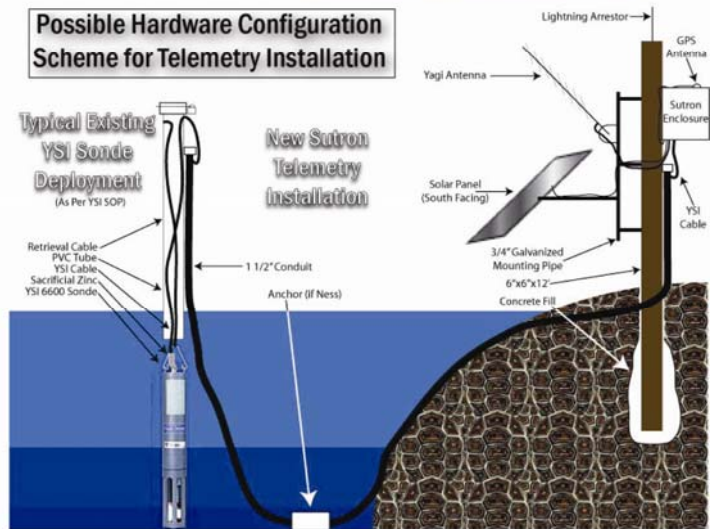

(Source: Poucher, J.)

Note: Even though the telemetry equipment is mounted inside a weather resistant control box, it is important to ensure that the control box is above water at all times. Therefore, mean higher high water, wave action, wind footprint and storm surges must be taken into account when designing a new monitoring platform or when an existing platform is evaluated for installation (EPA, 2002).

6.4.1.3 Antenna Considerations

A satellite antenna must be pointed directly at the orbital location of the satellite in order to obtain the best signal. To correctly point the antenna the latitude and longitude of the monitoring site must be known to determine the required azimuth and elevation (azimuth is the direction to which the antenna must be rotated and the elevation is the angle the antenna must be raised with respect to the horizontal).

The azimuth and elevation can be obtained from the following web page:

<http://www.dishpointer.com/>

The web site employs a mashup of Google Maps to find the required information to correctly set the antenna. The monitoring site location can be easily be found by entering the zip code, latitude and longitude, county, or any other information permitted by Google Maps to pin-point a specific DCP location.

In addition to point the antenna to the correct orientation, the antenna must have a good line of sight to the satellite to provide the best signal. The optimum is to have a free visual path between the antenna and the satellite (free of obstacles, such as dense forest, buildings, hills, *etc.*). Even though, good signals can be obtained with some types of obstructions, for examples, trees (not heavy canopy).

6.4.1.4 Installation Plan

It is a good practice to develop an installation plan. The plan defines objectives, describes the correct installation procedures, details the key critical factors that must be considered during the installation, describes the tools and supplies needed, and defines other activities and measurements that need to be executed.

It is a good practice to have a meeting with the installation team to go over the different installation activities before going to the field.

INSTALLATION PLAN: Things to take into account

- Read all manufacturers' documents thoroughly. It is a good practice to write down, in a check list form:
 - The correct order for installing the components.
 - Verification and inspection steps.
- Make sure to have all necessary detail installation drawings.
- Be sure to have the necessary information to install the solar panel and the antenna.
- Make a list of tools and supplies needed. A good practice is to go over the different installation steps while checking that the required tools and supplies are on hand.
- Be sure to have the adequate software to run the transmitter and to program the multiparameter sonde, so it can interface adequately with the transmitter (i.e. in YSI 6600 the sample and hold function must be enabled after it is calibrated for deployment).

Basic tools and supplies that are commonly required during a telemetry system installation are detailed in Table 6.3.

Tools	Supplies
Sockets with ratchet (deep well)	WD-40 or similar
Straight-bit screwdrivers (small, medium, large)	Silicone dielectric grease
Phillips head screwdrivers (small, medium)	Electrical tape
Open ended wrenches	Rubberized tape
Hammer	Cable ties (blacks are preferably given the higher resistance to UV than other colors)
Pliers	
Level	
Inclinometer	Washers 3/8"
Wire strippers	25 feet 14 gauge interior 2 conductor Romex wire with ground
Volt/Ohm meter	
Magnetic compass	

Table 6.3 Basic tools and supplies for telemetry installation

6.4.2 Installation Activities

Two types of installation procedures are described in this section as guidelines only:

- Telemetry systems mounted on wooden pilings & posts (e.g. pile, piers, wooden structures).
- Telemetry systems mounted on platforms that use antenna tower as a construction material.

These guidelines provide basic information on how to install the telemetry equipment. They can be used to select a specific configuration or as the basis to define new design features to meet the particular needs.

Note: The specific installation steps to follow must be evaluated based on each system and site's particular characteristics.

6.4.2.1 Telemetry Equipment Mounted on Wooden Piling & Post

The following guidelines detail Delaware National Estuarine Research Reserve installation practices, designed by Mike Mensinger.

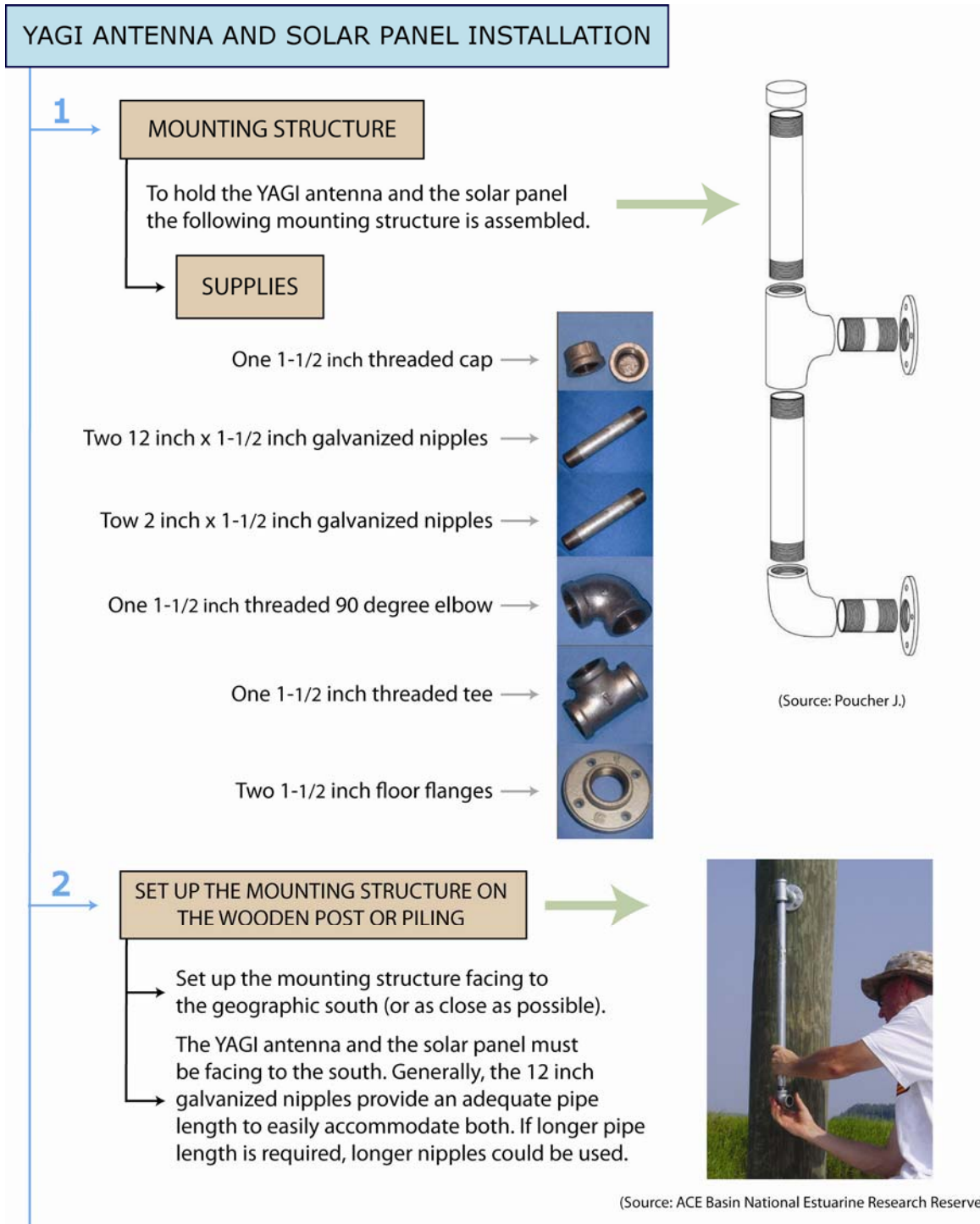

3

INSTALL THE YAGI ANTENNA

Mount the antenna at the top nipple of the mounting structure.

→ The antenna connector should be facing down.

Install the antenna and point it at the satellite.

→ Using a compass and inclinometer, adjust the antenna to match the required azimuth and elevation.

● Remember

- For elevation: horizon = 0° ; high noon = 90°
- To use the correct type of degree for the azimuth value (i.e. true or magnetic)

During testing, slightly adjustments are made to obtain the best signal.



(Source: ACE Basin National Estuarine Research Reserve)

4

INSTALL THE SOLAR PANEL

Mount the solar panel at the bottom nipple of the mounting structure.

Orient the solar panel to the geographic south and tilt it to the required angle.

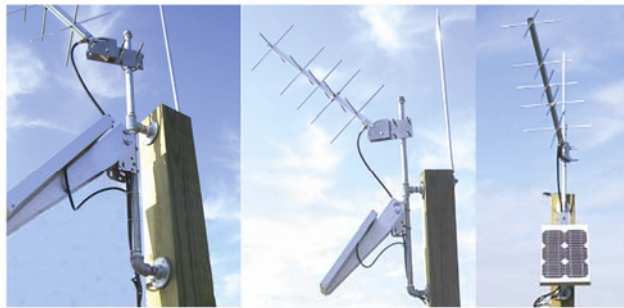

(Source: Delaware National Estuarine Research Reserve)

5

INSTALL LIGHTNING ROD

Mount the lightning rod (refer to section 6.4.2.3).

ENCLOSURE INSTALLATION

1

MOUNTING STRUCTURE

To hold the enclosure the following mounting structure is assembled.

SUPPLIES

One 24 inch x 1-1/2 inch galvanized nipple

Two 2 inch x 1-1/2 inch galvanized nipples

Two 1-1/2 inch threaded 90 degree elbow

Two 1-1/2 inch floor flanges

Two 1-1/2 inch unistrut pipe hangers

Two unistrut
(length equal to the enclosure width)

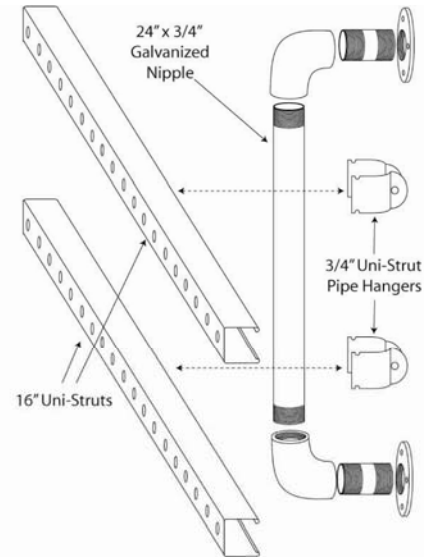

(Source: Poucher, J.)

2

SET UP THE MOUNTING STRUCTURE ON THE WOODEN POST & PILING

Try not to set up the mounting structure on the same side of the antenna and solar mounting structure.

3

INSTALL THE ENCLOSURE

Bolt the unistruts to the enclosure. Be careful not to damage the enclosure. Use washers as spacers to prevent the bolts to penetrate the interior of the enclosure (generally this step is done at the lab).

Secure the unistruts to the nipple using the unistrut pipe hangers.



(Source: AC Basin, Delaware and Weeks Bay NERR)

USING A MAST PIPE TO MOUNT THE SOLAR PANEL & ANTENNA

A mast pipe is a good alternative to use when:

- The existing platform has no room to adequately mount the solar panel and the antenna.
- The existing platform does not have the necessary height to adequately mount the solar panel and the antenna (i.e. there are some obstructions at the platform level, e.g. trees).
- The telemetry system would be installed on a pier, bridge, or shelter close to the monitoring station.

1

SET UP THE MAST PIPE

- It is a good practice to mark a line on the mast pipe to be used as the 0 degree mark (magnetic north).
- Mount the solar panel and the antenna on the mast pipe.
 - Depending on the station, the solar panel and antenna could be mounted later, once the mast pipe is secured.
 - The 0 degree mark can be used to place the solar panel and antenna facing the correct orientation.
 - Using a compass and inclinometer, adjust the antenna to match the required azimuth and elevation (this step can be done later; it would depend on the height of the pipe).
 - Further adjustments would be needed once all the equipment is installed.
- The antenna can be secured to the mast pipe using a double crossarm stand.
 - Using nu-rails and/or U-bolts with a double pipe mounting brackets, a pipe of the desired length and diameter is fastened to the mast pipe. A second pipe is fastened vertically at the end of the first pipe in a cross stand arrangement to hold the antenna.
 -
- Mount the lightning rod (refer to section 6.4.2.3).
- If the enclosure is mounted on the mast pipe, secure the unistruts to the mast pipe.
- Secure the mast pipe to the existing platform using any type of fastening device. Using the compass, the mast pipe is rotated so the mark is correctly positioned.

2

MOUNT THE REST OF THE TELEMETRY EQUIPMENT

- Mount the rest of the equipment as specified by the manufacturers.
- Set the antenna to the right elevation and azimuth, or make the necessary adjustments to the solar panel and the antenna so they are correctly positioned and oriented.

Note: A procedure to easily access the equipment must be designed. It is a good practice to designed this procedure at the begining of the installation plan given that it could trigger modifications in the planed configuration.



(Source: Rookery Bay NERR)



(Source: Campbell Scientific)



(Source: Rookery Bay NERR)



(Source: Chesapeake Maryland NERR)

Further guidelines on how to set the lightning rod and grounding the enclosure; how to set the GPS antenna; and some considerations when connecting the equipment, are given in section 6.4.2.3

6.4.2.2 Telemetry Equipment Mounted on an Antenna Tower

The antenna tower is an excellent supporting structure to mount the telemetry equipment in almost any type of monitoring platform. Generally, one or two 10-foot galvanized tower sections are employed to build a telemetry monitoring station or to overhaul and existing one (antenna towers can be easily secured to piers, pilings, docks, or any other type of existing structure).

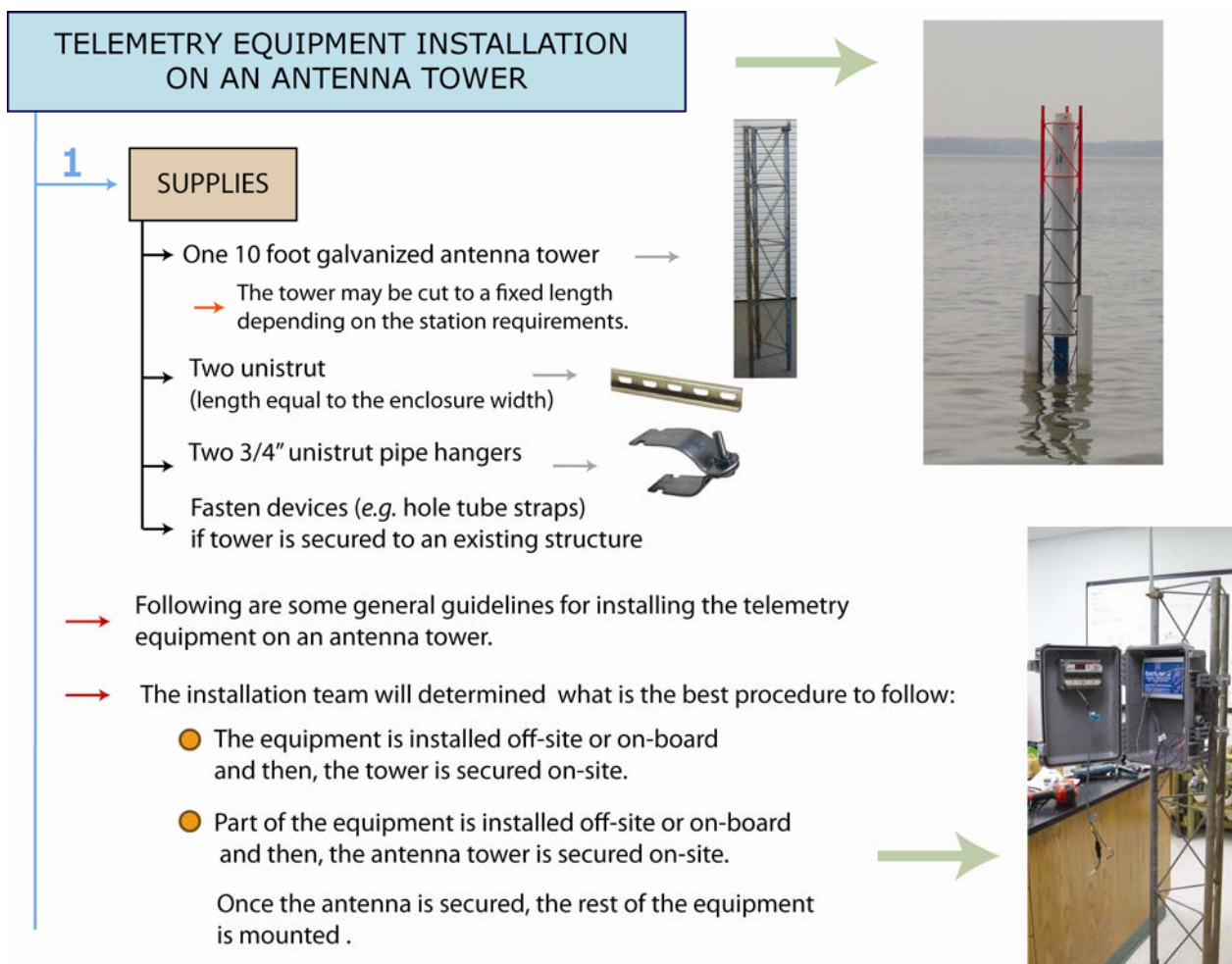

2

SET TOTAL TOWER LENGTH

The total tower length is determined to comply with the particular monitoring platform requirements:

- The tower must be cut.
- An additional 10 foot section must be added.



3

INSTALL THE SOLAR PANEL

If part of the equipment is installed on-board, it is a good practice to determine the orientation of the antenna tower at the monitoring station and mark the leg that is closely oriented to the 0 degree mark (magnetic north).

Then, mark one of the legs of the antenna tower (where the equipment will be mounted) to match the magnetic north leg.

Mount the solar panel and orient it to the geographic south and tilt it to the required angle.



4

INSTALL LIGHTNING ROD

Mount the lightning rod (refer to section 6.4.2.3).

5

SECURE ANTENNA TOWER

This step can be done later.



6

INSTALL THE YAGI ANTENNA

→ The antenna connector should be facing down.

Install the antenna and point it at the satellite.

→ Using a compass and inclinometer, adjust the antenna to match the required azimuth and elevation.

● Remember

- For elevation: horizon = 0° ; high noon = 90°
- To use the correct type of degree for the azimuth value (i.e. true or magnetic)

During testing, slightly adjustments are made to obtain the best signal.



7

INSTALL THE ENCLOSURE

Bolt the unistruts to the enclosure. Be careful not to damage the enclosure. Use washers as spacers to prevent the bolts to penetrate the interior of the enclosure (generally this step is done at the lab).

Secure the unistruts to the nipple using the unistrut pipe hangers.



8

CONNECT EQUIPMENT

Refer to section 6.4.2.3 for some connection points.

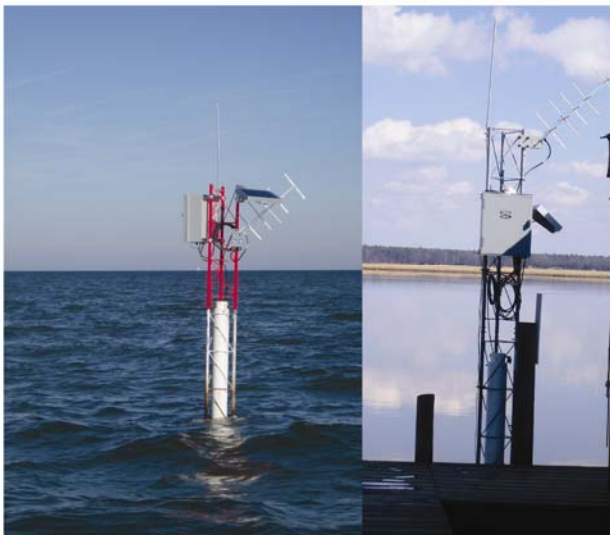

6.4.2.3 Additional Installation Considerations

Guidelines for installing the lightning rod and grounding the enclosure, and installing the GPS antenna are provided in this section. In addition, several points to take into account when connecting the telemetry equipment are provided.

LIGHTNING ROD INSTALLATION AND GROUNDING OF ENCLOSURE

- 1

SUPPLIES

 - Lightning rod.
 - Ground rod (e.g. 6 foot copper rod).
 - Mast clamp or mounting base (vertical or horizontal).
 - Lightning conductor: aluminum or cooper wire.
- 2

MOUNT LIGHTNING ROD

 - Wooden Structure: the lightning rod can be mounted
 - On the post & piling: fasten the lightning rod on the top part of the post & piling using a vertical or horizontal mounting base. Position the mounting base approximately 2 inches (5 cm) from the top of the post & piling.
 - On the cap of the galvanized nipple: fasten the lightning rod onto the cap using a bolt.
 - Antenna Tower or Mast Pipe:
 - Fasten the lightning rod on the top part of the pipe or tower using a mast clamp. Position the mast clamp 2 inches (5 cm) from the top of the mast.
 - Insert the aluminum or cooper wire in the lightning rod mounting bracket, clamp or base and fasten the screws or bolts.
 - Make sure the lightning rod and conductor wire are tight.
- 3

GROUND THE ENCLOSURE

 - Connect a second wire to ground the enclosure and route it down to where the ground rod will be located.
- 4

DRIVE GROUND ROD INTO THE GROUND

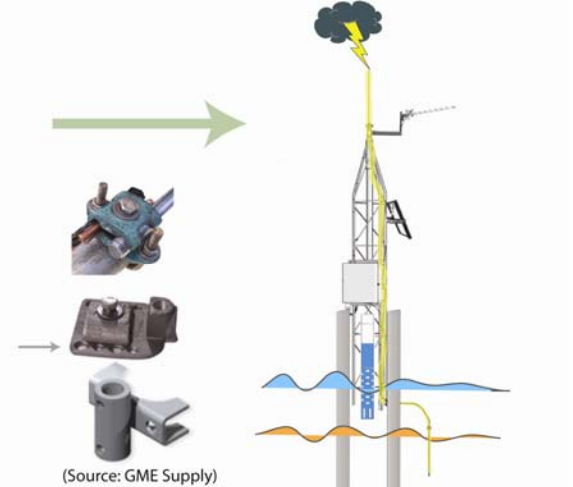

 - Cut ground wires to adequate length.
 - Loosen the bolt from the clamp at the ground rod. Insert the conductor wire coming from the lightning rod and the conductor wire coming from the enclosure into the hole behind the screw. Tighten the screw so it holds the wires firmly .
 - Make sure the conductor wires do not have sharp bends.
 - Drive the ground rod into the ground close to the monitoring station.



(Source: GME Supply)



(Source: ACE Basin and Jobos Bay NERR)

Note: It is a good practice to use a lightning arrester in locations with heavy lightning exposure (Sutron).

GPS ANTENNA INSTALLATION

A GPS antenna is required in a satellite telemetry stations to synchronize the internal clock of the transmitter with the atomic time provided by the GPS satellites.

INSTALLATION CONSIDERATIONS

- Place the GPS antenna in the most open space possible.
- The antenna must have a clear view of the full sky so it can track the satellites.
 - Obstructions would cause the GPS antenna to fail.
 - For example, during winter ice and snow could cover the GPS antenna and degrade the signal to unacceptable levels.
- If a magnetic mount GPS antenna is used, it can be placed on top of the enclosure. For plastic enclosures an epoxy adhesive can be used.
- Mount the antenna so it is protected from strong winds or other weather events that may displace the antenna.
- In most cases, the magnetic GPS antenna comes with a small size coaxial cable. If the monitoring station is located in an area where rodents can damage the cable, it is a good practice to place the cable inside a conduit.



WHEN TO USE A GPS BULLET ANTENNA

- The GPS bullet antenna must be used when (Sutron):
- When the cable length of the magnet mount antenna is not long enough.
 - The new standard cable lengths for the GPS bullet antenna are 5 or 10 meters.
 - In any location where the antenna must be mechanically mounted.
 - Application examples include buoys, towers, ocean exposure, or anywhere with high winds or other problems that might move a magnetic antenna
 - When an application requires a more robust cable..
 - This antenna option provides a UV-rated cable approximately 0.3 inches in diameter.



Note: Typically, the system will take an average from 5 to 15 minutes to acquire position fix information and to acquire time. If the system takes longer than this to acquire the time, you may need to reposition the GPS antenna (CDMO-NERR).

CONNECTION CONSIDERATIONS

→ The manufacturer's installation instructions must be read thoroughly before beginning connecting the different equipment.

→ It is a good practice to get professional help (e.g. technical representative) to assist you during the first telemetry installation.

MULTIPARAMETER SONDE

→ The multiparameter sonde must be configured to enable the transmission of data (e.g. in a YSI multiparameter sonde the "sample and hold" feature must be active).

→ Commonly the way the multiparameter reports the data needs to be adjusted depending on the types of probes that are connected. If the report menu is not set correctly, the wrong data will be transmitted.

TRANSMITTER

→ The RF connector must be connected to the antenna before it is powered on. Damage can result to the transmitter if powered on without a load.

→ Be sure to load the right program; if not, the transmitter might transmit at the wrong time and channel.

POWER SYSTEM

→ The last two things to connect are the battery and the solar panel. Connect the battery first and then apply the solar power connection to the regulator.

COAXIAL CABLE & INSTALLATION

→ Coaxial cables are not meant to be kinked.

→ Even though, coaxial cable are flexible, they should never have a sharp bend or kink.

→ A kink anywhere in the cable causes a mini reflection to occur, creating a second signal and reducing the effectiveness of transmission.

→ A kinked or twisted cable can not be corrected. It is recommended to replace the cable.

→ To prevent a kink or a twist from occurring, unroll the wire as if it were coming off a spool. Once laid out straight, without any twist, route the cable to the destination like a snake.

→ Pre-plan the cable path prior to making the installation to prevent any hard turns.

→ Excess coaxial cable can be carefully coiled in a series of loops and tied to the back of the enclosure and/or tower with a piece of #14 solid wire. Try not to make the loop too small.

→ Cable ties are generally used to secure the cables to the station. The disadvantage of using cable ties is that in the long run the sun will make them brittle and they may break. An alternative method is to use # 14 gauge solid wire. If cable ties is the option, use BLACK cable ties.

FIRST TRANSMISSION

→ It is a good practice to contact the technical representative before applying power. They can walk you through all the steps to test the equipment and connections before the first transmission.

→ Be sure the battery is fully charged. The battery voltage needs to be above certain level for the transmitter to operate.

For example, if the installation was completed in the late afternoon, the first transmission may not come until the next day after a morning recharge period.

→ Antenna adjustments are commonly made to improve transmission. For example, adjusting the antenna may increase power level of 44 db to 47 db, which is a great improvement. The higher the score, the more robust transmissions will be during inclement weather.

→ It is a good practice to have someone at the host site to check the incoming data during the first transmission. If needed, host site personnel can communicate to field personnel to make the necessary corrective actions.

Notes:

- It is a good practice to take several pictures of the station, in particular one of the connections. A laminated copy can be stored in the enclosure.
- Place one or two desiccant packs inside the enclosure.

6.5 REFERENCE

Allen Gale. **An Introduction to Telemetry**. Communication Notes. Department of Electrical and Computer Engineering & Technology at Minnesota State University, Mankato.

Barrett Eric C. and Leonard Frank C.. 1999. **Introduction to Environmental Remote Sensing**. Published by Routledge

Blake, Henke. 2007. **A Final Report Submitted to The NOAA/UNH Cooperative Institute for Coastal and Estuarine Environmental Technology (CICEET)**. North Star Science and Technology, LLC.

<http://ciceet.unh.edu/news/releases/springReports07/pdf/henke.pdf>

Campbell Scientific. **Power Supplies**. Application Notes Code 5-F. Revision 9.

<http://www.campbellsci.com/documents/technical-papers/pow-sup.pdf>

Campbell Scientific. **UT 10 Weather Station Installation Manual**. Revision 4/98

<http://www.campbellsci.com/documents/manuals/ut10.pdf>

Carden Frank, Russell P. Jedlicka, Robert Henry. 2002. **Telemetry Systems Engineering**. Published by Artech House.

Energistics. **.217-AZIMUTH-CORRECTION**. Geoshare Data Model, Version 13.0

<http://w3.posc.org/GeoshareSIG/technical/GDM/v13.0/217-AZIMUTH-CORRECTION.php>

L-3 Communications. 2008. **Telemetry Tutorial**. ML1800 Rev. A

Landau, Charles R. 2008. **Optimum Orientation of Solar Panels**. MACS Lab.

<http://www.macslab.com/optosolar.html>

NASA. **Isolation at Specified Location**. <http://aom.giss.nasa.gov/srlocat.html>

Photovoltaic Education Network. **Photovoltaics**.

<http://pvcdrom.pveducation.org/index.html>

Poucher, Jay. 2006. **Sutron Telemetry Installation Notes**. Centralized Data Management Office. NERR. Internal Document. <http://cdmo.baruch.sc.edu>. To contact Jay Poucher jpoucher@sc.edu

Poucher, Jay. 2006. **Campbell Telemetry Installation Notes**. Centralized Data Management Office. NERR. Internal Document. <http://cdmo.baruch.sc.edu>. To contact Jay Poucher jpoucher@sc.edu

Precision Measurement Engineering. **Data Transmission**. <http://www.pme.com/>

The Gulf of Mexico Program, U.S. Coastal GOOS and NAML. 2000. **Harmful Algal Blooms Observing System (HABSOS)**. Design and Implementation Plan for a Pilot Project for the Coastal Component of the U.S. Integrated Ocean Observing System: Detection and Prediction of Harmful Algal Events in the Northern Gulf of Mexico. Workshop Report. 27 November - 1 December, 2000 Pensacola Beach, Florida <http://hpl.umces.edu/projects/HABSOS.pdf>

Solar Plots Info. **Definitions**. <http://www.solarplots.info/pages/definitions.aspx>

Solinst. **STS Telemetry Systems**. Model 9100 Data Sheet.

Solinst. **Telemetry Systems**. <http://www.solinst.com/>

South, Scott. 2005. **Environmental Monitoring: Guide to Selecting Wireless Communication Solutions**. WaterWorld. Pg. 48.

Stein, Matthew. 2008. **When Technology Fails: A Manual for Self-Reliance, Sustainability, and Surviving the Long Emergency**. Chelsea Green Publishing.

U.S. Environmental Protection Agency. 2002. **Delivering Timely Water Quality Information to Your Community**. The Chesapeake Bay and National Aquarium in Baltimore EMPACT Projects. Office of Research and Development. National Risk Management Research Laboratory Cincinnati. EPA625/R-02/018

6.5.1 Photo Reference

Figure 6.2 - National Oceanic and Atmospheric Administration (NOAA) Photo Library Image. Image ID: spac0256, NOAA In Space Collection.

(This page is intentionally blank.)