

A Practical Manual for Remote Setting in Virginia

Michael S. Congrove
Virginia Shellfish Growers Association & Virginia Seafood Council

Dr. James A. Wesson
Virginia Marine Resources Commission

Dr. Standish K. Allen, Jr.
Virginia Institute of Marine Science

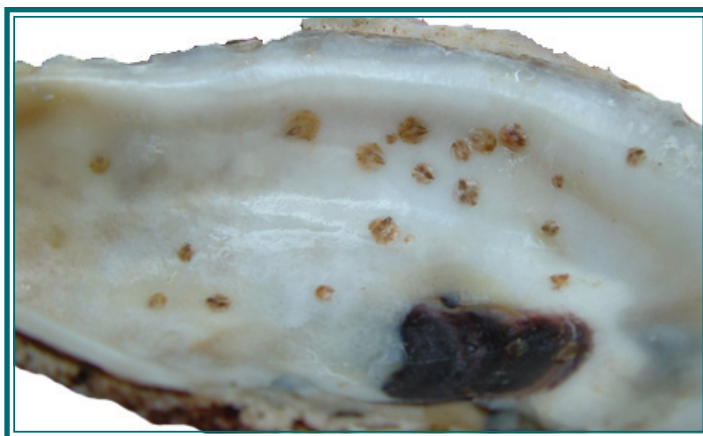

Funded by: Virginia Fishery Resource Grant Program



In Cooperation with:

Bevans Oyster Company
Cowart Seafood Corporation
J&W Seafood
Kellum Seafood
Mobjack Bay Seafood
Purcell's Seafood
Sea Farms
Shore Seafood
Shores and Ruark Seafood
Terry Brothers

January 2009

VSG-09-01

VIMS Marine Resource Report No. 2009-1

Additional copies of this publication are available from Virginia Sea Grant at:

Sea Grant Communications
Virginia Institute of Marine Science
P.O. Box 1346
Gloucester Point, VA 23062
804-684-7170
vsgpubs@vims.edu
www.vims.edu/adv/



This work is a result of research sponsored in part by NOAA Office of Sea Grant, U.S. Department of Commerce, under Grant No. NA96RG0025 to the Virginia Sea Grant Program. The views expressed herein do not necessarily reflect the views of any of those organizations.

Table of Contents

Section	Page
What is Remote Setting?	1
The History of Remote Setting.....	1
Why Remote Setting Now?	2
Remote Setting Potential	2
How Do You Do It?	3
Site Selection and Facility Setup	4
Shell Preparation.....	7
Tank Preparation.....	8
Oyster Biology	9
Setting.....	10
Planting.....	12
Growout	13
Facility Costs	14
Summary	14
References	15
Appendices.....	16
Facility Set-Up Guidelines	
Vendor List	
Setting Protocol	
Setting Optimization	

What is Remote Setting?

Remote setting is a method of oyster seed production resulting in several baby oysters (spat) attached to old oyster shell (see photo-right). The resulting oyster seed is referred to as “spat-on-shell”. This method is in contrast to single oyster seed production (cultchless) where the result is individual oysters grown out in bags or



cages. Because the small spat are attached to shell, seed can be moved and planted on the bottom at small sizes, soon after setting (7-10 days) and do not require a nursery phase or any further attention for that matter after planting. The resulting harvestable product



resembles wild caught oysters (see photo- left) and can likely realize a yield at or greater than two bushels of market oysters for every bushel of spat-on-shell planted.

Remote setting based oyster culture (remote culture) is not unlike seed transplanting of the past where sub-market

size seed oysters were transferred from a seed bed to a grow-out bed, and then harvested when market size. The difference in remote culture is that oyster seed is produced, rather than caught. The control offered by production allows for the use of domesticated and selectively bred oysters which should perform much better than the genetic grab-bag of wild-caught seed oysters.

The History of Remote Setting

Remote setting was pioneered in the Pacific Northwest of the U.S. using the Pacific Oyster (*Crassostrea gigas*) as an alternative to the unreliable and costly task of collecting or importing oyster seed for growout. The first remote set was performed in California in the early 1970s, but the process did not really take off until 1978 when a hatchery in Oregon (Whisky Creek Oyster Hatchery) was constructed exclusively for the purpose of producing oyster larvae for remote setting. Since then remote setting has boomed in the Pacific Northwest and is the cornerstone of an industry worth \$40 million (2006) annually.

While remote setting is relatively

new to the oyster industry in Virginia with the first recent remote sets being completed in 2005, it is not the first time remote setting has been attempted in Virginia. In the early 1980s (about the same time remote setting was taking off in the Pacific Northwest) Virginia Sea Grant (VASG) setup a program to investigate remote setting at the request of the Virginia oyster industry and as a result of worry over disease related mortalities.

Several remote sets and spat-on-shell plantings were successfully completed at various industry sites via a remote setting tank constructed by VASG and trailered to the respective sites. The production method failed to catch on however, which was attributed to several factors: 1) survival of planted oysters was extremely low due to the same high

disease pressure that was killing wild oysters, 2) early mortality of planted spat-on-shell was extremely high due to flat worms (*Stylocosus ellipticus*), particularly at the higher salinity locations, 3) there were no large hatcheries in Virginia capable of producing enough larvae to support any sizeable scale-up of production and there was little interest in new hatcheries as a result of two, recent and high profile hatchery failures in the 1970s still fresh in the minds of industry, and 4) a modest resurgence of the natural population during the VASG remote setting experiment faded what little interest was left in the technique. The program was therefore abandoned (Mike Oesterling, VASG).

Why Remote Setting Now?

If remote setting failed so miserably in the 1980s in Virginia, why is it being reinvestigated as a means of oyster seed production? Today these problems do not appear as insurmountable as they once were.

1) High disease related mortality in wild populations, especially after year two, is still a serious problem. However, culturing oysters allows for selective breeding which has been done for livestock for centuries. Selective breeding results in the retention and emphasis of desirable traits and the loss of less desirable ones. The idea is the same in selectively bred oysters where in this case, oysters are bred for resistance to disease. Selective breeding can and is also being used to increase growth and yield of oysters. In Virginia, the Aquaculture Breeding and Technology Center (ABC) at the Virginia Institute of Marine

Science (VIMS) is at the forefront of the selective breeding effort and is available to provide growers with such selectively bred stocks for propagation.

2) High post-planting mortality due to predation is still a problem and is often as much as 50%. While this may seem too high for profitability of remote setting, yields of two bushels of market oysters for every bushel of spat-on-shell planted (2:1) and greater are still possible despite this high early mortality.

3) Hatchery capacity, while less than demand in Virginia, is certainly more than it was in the 1980's and is rapidly expanding. The Virginia Marine Resources Commission (VMRC) spat-on-shell program alone has seen a 29 fold increase in larvae production from 30 million in 2005 to 880 million in 2008. Despite this significant increase, demand for oyster larvae still exceeds supply. The current

status of the Virginia oyster culture industry is such that demand has not yet been sufficient enough to leverage the necessary increase in supply. This situation is likely nearing its end with at least one new oyster hatchery coming to Virginia in 2009 and possibly more in the near future. The next few years will see considerable increases in Virginia hatchery capacity.

4) While a resurgence of the natural population is not out of the question, resurgence to an adequate and dependable level to supply the Virginia oyster industry is very unlikely. It is time for the industry to take its future into its own hands. The product stability and quality that can be offered by aquaculture is much greater when compared to the alternative of wild capture and the industry is sure to prosper from a turn to culture.

Remote Setting Potential

The marketable product offered by remote setting will be primarily for shucking. Because spat-on-shell is grown in clumps on the bottom, shell shape will be similar to wild caught. Some oysters may be acceptable for half-shell, but the

majority will be most useable as a shucked product. For this reason remote setting is not meant to take the place of single oyster culture (which does produce consistently, high quality half shell

oysters), but to compliment it with a means of producing, at large scale, oysters for shucking. Remote culture requires much less labor than does single oyster culture making it a more economically feasible



option for producing shucking product.

The majority of oysters shucked in Virginia (approximately 500,000 bushels annually) are shipped into Virginia from the Gulf of Mexico states. This product source is often unreliable, and has become

increasingly expensive given the rising cost of fuel. As remote culture gains traction, local product will be a good asset for processors who experience interruptions in product stream. Private leases in Virginia, which have been unused for many years, could again become valuable for lease holders to replant and grow oysters profitably.

Spat-on-shell also has potential for being a more attractive shucking product during the summer months. Thanks to the hatchery phase,

growers can select triploid (a process that renders oysters sterile) larvae for their-spat on-shell. Triploid oysters cannot spawn, giving them good meat yield in the summer when normal oyster meat yield is poor as a result of spawning.

On a smaller scale remote setting has the potential to turn wild oyster harvesters almost seamlessly into oyster culturists. Remote culture is very similar to seed transplanting of the past, which was itself a form of oyster culture. Oystermen

could do remote setting in their backyards or they could purchase spat-on-shell from a remote setting seed market, where spat-on-shell is produced and sold as seed by a remote setting facility. Either way, income could be generated and could be a means of providing oystermen with seed that could be grown out using methods with which they are familiar. No equipment aside from what they already have (boat, dredge, etc.) would be necessary.

How Do You Do It?

Getting into remote setting based aquaculture is not necessarily expensive or difficult. Facility set-up costs can be relatively modest with the biggest initial investment being the purchase of eyed oyster larvae for setting. Once the facility is set up and producing spat-on-shell, the grow-out end of things will be very familiar to those

experienced in more traditional oyster culture methods (i.e. transplanting) as spat-on-shell seed is handled similarly to transplanted wild seed.

Simply stated, remote setting is accomplished by first filling large tanks with some sort of containerized setting cultch (usually oyster shell) and local conditioned baywater. Eyed oyster

larvae are then added to the setting tanks and allowed to set for three days. After three days unfiltered baywater is constantly pumped into the setting tanks to bring food to the newly set spat. After about seven days of waterflow and feeding, the spat-on-shell is large enough to be planted, and is taken out of the tank, transported to the planting site, and spread loose on the bottom. See diagram below.



Below are the details of remote setting: how to pick a site, how to set-up a setting facility (including

preparing the shell), how to prepare a tank for setting, how to set a tank, what is the behind-the-scenes

biology of setting, and how to plant the newly set spat-on-shell.

Site Selection and Facility Setup

A typical remote setting facility consists of only a handful of items. Major equipment necessary for the facility includes tank(s), water pump(s), air blower(s), heater(s), PVC plumbing, a shell cleaner, and machinery to move shell. A satisfactory site for this equipment would typically include a stable area in close proximity to the water with plenty of room for cleaning and storing shell. However, considering the current price of waterfront property (>\$200,000 per acre in Virginia), ideal sites may be limited to those that already have established operations on the water. For newcomers to the field, or perhaps the entrepreneurial waterman interested in remote setting, but with only a slip for his boat and a bottom lease, there are other options. While waterfront is certainly advantageous, it is not absolutely necessary as tanks could with some work be setup on a barge, or constructed to float in the water. The actual footprint of the setting tank(s) is quite small. A small area may be available next to marinas, crab-shedding facilities or other water-dependent sites, while shell could be cleaned and stored anywhere, and then trucked to the setting facility when needed. There is also potential for cooperative setting where, for example, a watermen's group could pool their resources to construct a facility for shared use.

When choosing a site for remote setting, be sure to first check the water quality. One of the best

Performing a Test Set

Several test sets should be performed before investing in a site. Items needed for a test set include:

- 5 gallon bucket
- air pump (little one from pet store or bait shop is fine)
- air line and air stone
- 50 micron filter bag
- clean oyster shell
- three thousand larvae
- magnifying glass

Put the air line and air stone in the bottom of the bucket, then add 30 oyster shells to the bucket. Pour about 4 gallons of water through the filter bag and into the bucket with the shells. Add the larvae to the bucket as described in the setting section below. Place the bucket out of direct sunlight, plug in the air pump and allow to set for three days. On the third day, pour the water out and count the number of spat on each shell using the magnifying glass. Setting rate will be equal to the average number of spat per shell since 3,000 larvae were added, but the test is really just examining feasibility. Total cost for this set-up is only about \$25. Any hatchery should give you the larvae free of charge.

indicators to look for at a potential site is the presence of oysters. If there are oysters on the bottom, bulkheads or pilings, then remote setting should be biologically feasible. Sites with moderate to significant water flow are best.

Setting Tanks- Remote setting tanks can be rectangular or circular and should be relatively shallow (not more than four feet deep) to ensure ease of loading and unloading. Tanks can be plastic, fiberglass, or metal (if a plastic or rubber liner is used in the tank). Fiberglass is the most commonly used tank type. When selecting tanks, a good rule of thumb is that 2,000 gallons worth of tank space is necessary for every 100 bushels of spat-on-shell to be set. So if you want to set 300 bushels at a time, you could have one tank of approximately 6,000 gallons,

two tanks of approximately 3,000 gallons each, etc. Tanks should be placed as close to the water as possible to reduce the distance spat-on-shell must be moved when loading it onto the boat for planting.

Tanks must be plumbed to both receive and drain water. The drain should be in the bottom of the tank and capable of receiving a standpipe that will maintain the water level at just below the top of the tank. The filling location should be as far as possible from the drain stand pipe so that water entering the tank does not immediately exit. Aeration of the tanks is necessary and is accomplished via a pvc pipe manifold on the tank bottom with 1/16 or 1/8 holes drilled every 6 or 12 inches respectively. The manifold may take any shape

that is convenient to you so long as air is distributed relatively equally throughout the tank. Air is forced through this manifold by a

regenerative blower discussed later. Below is a schematic of a typical tank set-up, a few tank examples,

as well as a possible air manifold arrangement.

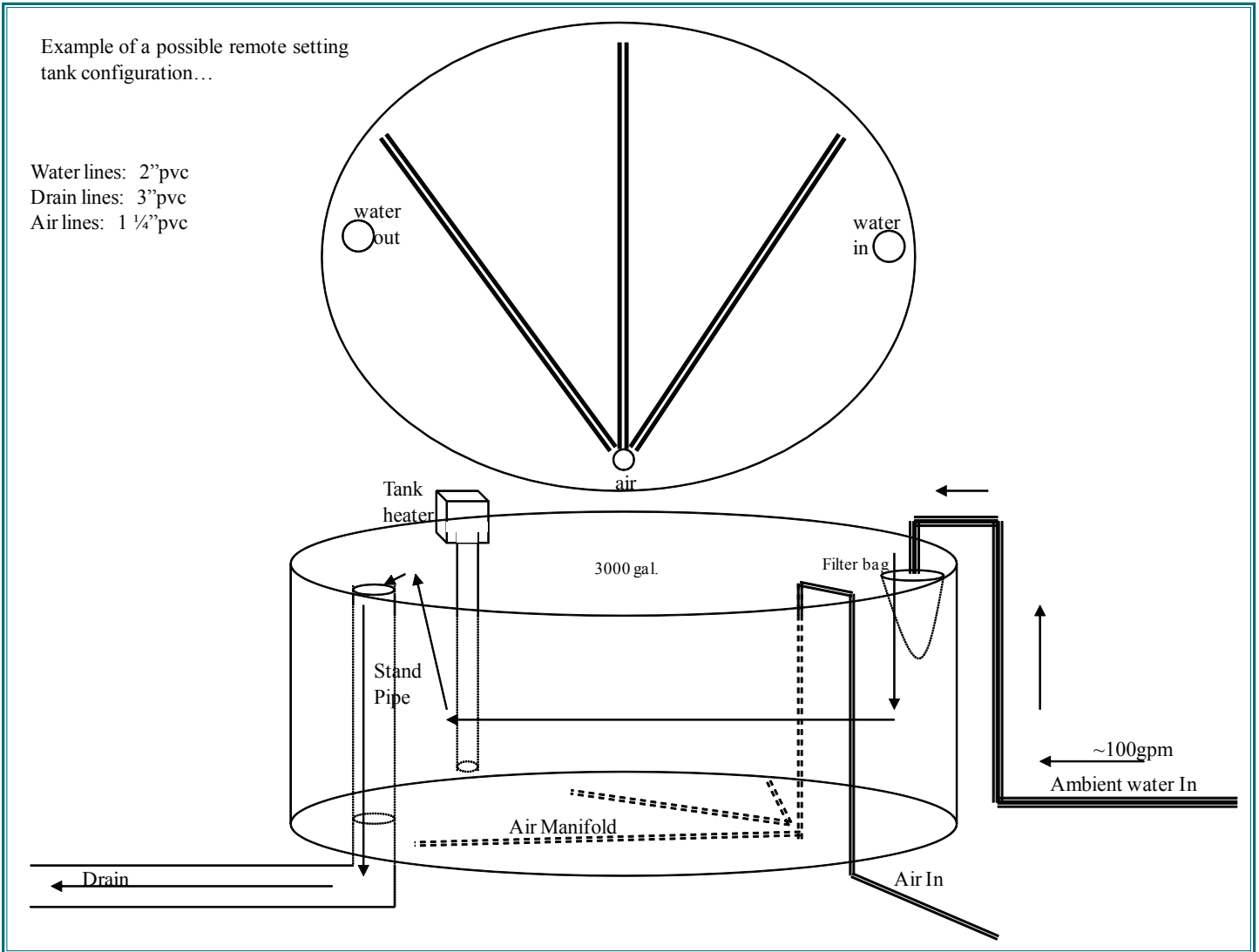

Below is a typical round tank setting facility to highlight a few details of the setting tanks.

1. Air delivery lines to the air manifold should be plumbed at least 12 inches above the side of the tank to prevent water from siphoning out of the tank into the blower when it is turned off.
2. In this system, water delivery lines split at the tank allowing for dual filter bags, decreasing the amount of clogging during filling.
3. Immersion heaters may be required at the beginning and/or end of the season and will be discussed later. However, when using these heaters ensure that the heating element is submerged according to the manufacturer's recommendations or a heat-kill fuse will turn off the heater.
4. Remember that the closer the tanks are to the water, the quicker and easier the planting process will be.
5. To ensure that tanks are capable of draining completely, drains should be located on the bottom of the tank. To accommodate drain plumbing, in most cases, the tanks must be raised off the ground. If setting up tanks in a new area, this could be accommodated ahead of time with a drain trough.
6. Remember to position the drain and water delivery opposite one another so that water entering the tank does not immediately exit.

Many other tank designs are possible. Square or rectangular tanks made from concrete, cinderblock, swimming pool liners, or fiberglass are acceptable.

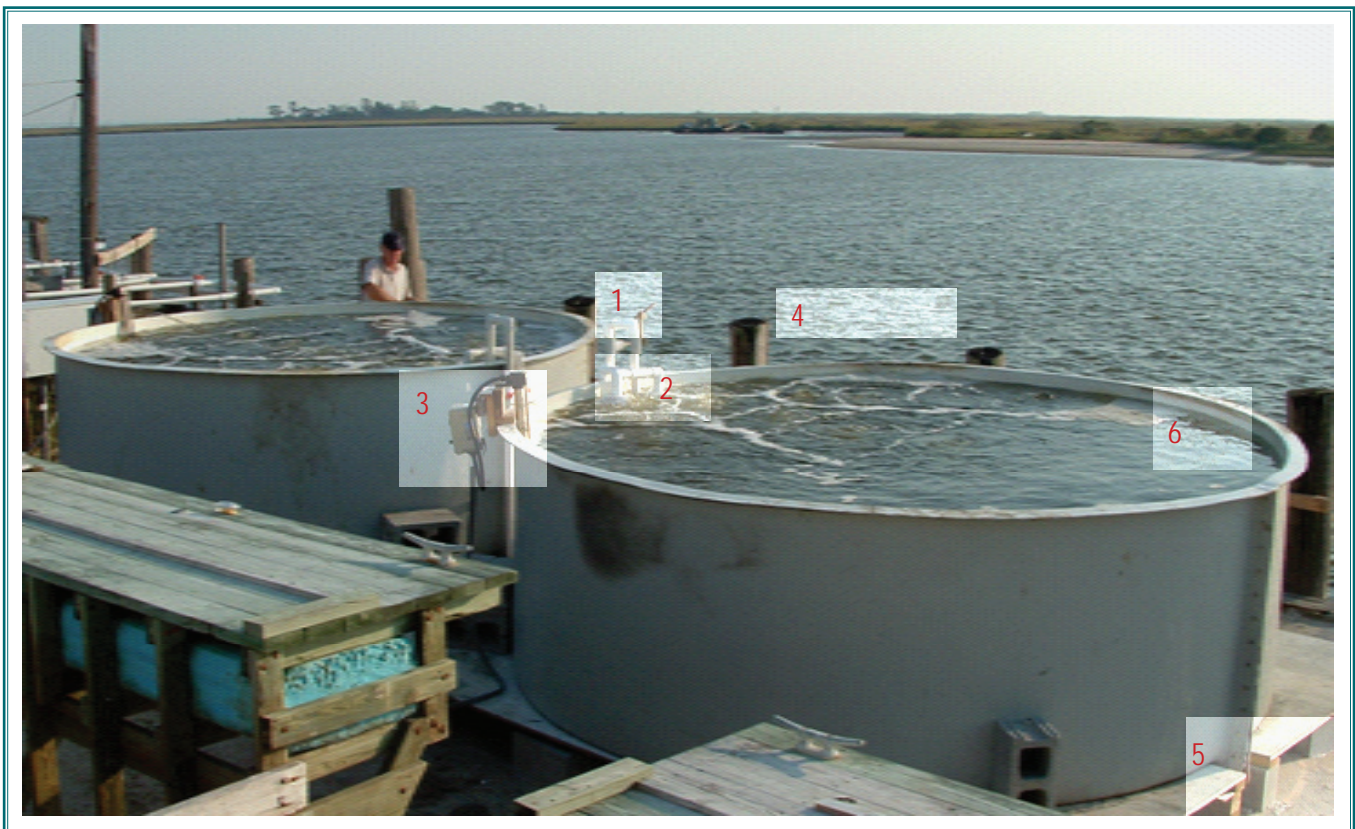

Water Pumps- When selecting a water pump for your setting tanks a good rule of thumb is to have a minimum of 50gpm of flow for every 100 bushels of spat on shell in the tank. For example, in a 6,000 gallon system containing 300 bushels of spat-on-shell, a 200gpm pump is necessary. This allows for 50gpm of flow for every 100 bushels of spat-on-shell,



Photo: aquaticceco.com

plus 50gpm extra for any performance loss that might occur due to friction loss or plumbing

fouling. Be sure to consult the pump performance curves when selecting a pump to ensure that given your specific amount of head loss, there is still enough flow available. Pumps similar to those used for soft-crab shedding facilities are often adequate for remote setting operations.

Air Blowers- Regenerative air blowers are best for remote setting systems given the large size of the tanks. A good general rule of thumb when selecting a blower



Photo: aquaticceco.com

is 1/4 horsepower per thousand gallons of water in your

system. This should be sufficient to adequately aerate your setting tanks as long as they are not much deeper than four feet. Remember it is advantageous anyway to have relatively shallow tanks to ease tank loading and unloading.

Heaters- Heating setting water may be necessary at the beginning and end of the season. Water temperature at the time of setting should be between 25°C and 30°C (77°F-86°F) with an optimal temperature of about 28°C (82°F).

Immersion heaters (those with a heating element that is simply put into the tank) are sufficient for remote setting in

Virginia as early as May, as the changes in water temperature are relatively modest. To set any earlier than May, would likely require a more substantial heating method such as a heat pump or boiler. A good



Photo: aquaticceco.com

rule of thumb when selecting an immersion heater is that it requires 4000 watts of heater to raise 1000 gallons of water 5°C (~10°F). Between the months of May and September, a change of more than 5°C should not be necessary. Titanium heating elements offer the best durability in saltwater. Appendix 1 provides the guidelines for facility setup.

Shell Preparation

Oyster shell used in remote setting must be aged, washed, and containerized. Oyster shell should be allowed to age for a period of at least one year to ensure that there is no organic tissue left on the shells that may foul water quality during setting. Aged shell must then be washed to remove the grit (small bits of oyster shell). Oysters will set un-preferentially on the shell and grit, however containment and transport of the grit is impossible, therefore any oysters that settle on this grit will likely be lost in subsequent transport. Washing also removes any debris or impurities that may have made their way into the shell pile. Cultch must be containerized

so that it is easy to move in and out of tanks and so that all shells are accessible to settling larvae. Larvae can penetrate no more than approximately 3-6 inches into a shell pile. If shell was simply dumped in a pile in the tank, larvae could not reach the center of the pile, thus containerization allows arrangement of the cultch into smaller units with access space in between.

Washing and containerization is often part of

the same process. Shell washers are often modified from another piece of equipment. One common shell washer resembles a tumble grader (photos-below and on following page) where shells are dumped in a hopper and deposited





on a conveyer that brings them up to an inclined, rotating, perforated column with water jets. The shells exit the rotating column and go down a shoot to the container. Another common shell washer is a modified oyster washer where shells are dumped into a hopper which drops the shell onto a chain conveyer. The shells pass through an area with several high pressure water jets then fall down a shoot to the container. Shell washing can be as simple as a hose and wash-down pump if the grower works



in small batches or has a way to wash all shell.

Shell containerization in Virginia has to date been done primarily using bags (photo-below left). The bag material is a plastic mesh sleeve (8-10 in. diameter) that is cut longer than the desired finished shell bag

length. One end of the sleeve is closed, clean shells enter the bag through the still open end, and then this end is closed. Generally 1/3 to 1/2 bushel of shell are placed in each bag, which is 2-3 feet in length. Shell bags are sometimes stacked onto pallets and the pallets lifted into the setting tanks, or bags are loaded by hand, one-by-one into the setting tanks. Other shell containment possibilities are cages. Cages (photo-right) offer increased mechanization

and drastic reductions in labor associated with bag making and handling. Cage material proven safe for larvae include stainless steel and plastic-coated wire. Plastic-coated wire must first be seasoned in the water for a period of at least one week before

use. Galvanized metal is toxic to larvae and should not be used. If considering containment cages, be sure to perform some test sets with the desired material to ensure it is not harmful. Also, note that if a cage type containment unit is used for shell containerization, the planting vessel must be able to accommodate loose shell. The cheapest way to do this is to use a flat deck vessel and float the spat-on-shell off with a high volume, low pressure water hose. The other option is to use a conveyor and spreader system. These will be covered in more detail in the planting section. A material list with appropriate vendors for facility equipment, bag material, and larvae can be found in Appendix 2.



Tank Preparation

It is important to stay in contact with the hatchery from which you will be receiving larvae, so that you have your tanks ready when larvae are available. Oyster larvae can survive out of the water in a refrigerator for up to seven days, but it is best not to exceed five days in the refrigerator. Some of the larvae that you receive will

likely have already been in the refrigerator at the hatchery for a couple days, so it is best to set larvae either the same day or the next day after you receive them.

Well in advance of the beginning of the season it is advisable to check all your systems, including air and water to ensure all equipment is working properly. Shell can be loaded into the tanks well in

advance of receiving larvae. This way you can be ready to set at a days notice. When you have received an estimated larvae delivery date from the hatchery, plan on filling the tanks with filtered seawater on the second half of an incoming tide approximately 24 hours prior to setting. By filling the tanks a day early, water-borne bacteria which attract settling larvae have time to colonize the

shells. Filling the tanks on an incoming tide ensures that the best quality water is obtained and reduces the chance of drawing water that may be contaminated by runoff from upriver. Water should be filtered at the very least, through a 75 micron filter bag. There is some evidence to suggest that more finely filtered water (down to 15 microns) results in better setting success (See the setting optimization, Appendix 4).

Prior to filling the tanks, turn on the air blower so that water does not enter the air lines. Once full, the water pump should be turned off as the tank will remain static for three days once the larvae have been added. The air blower remains on until the tanks are drained and the spat-on-shell is removed. If heaters are to be used, turn the heaters on after the tanks are completely full. The heaters should remain on approximately half a day longer

than the tank is static. After three days with only air, the water pump is turned back on to create a flow-through to supply food to the newly set spat. The heaters are left on half a day to ease the temperature transition from warm setting water to cooler ambient baywater. Filtration is not necessary when pumps are turned back on for the seven day flow-through period.

Oyster Biology

Before getting into the details of setting, it is important to first understand the relevant aspects of oyster biology. Oysters have a complex life cycle meaning it is comprised of more than one

part. There are two main parts to the life cycle: the free-swimming larval phase and the non-mobile adult phase, which are separated by a metamorphosis of sorts. Adult oysters are broadcast spawners meaning they release sperm and eggs directly into the water column

for fertilization. Fertilized eggs develop in the water column from embryos to pediveliger larvae through a series of stages that lasts two to three weeks, including trocophore (not shown), d-stage, veliger, and pediveliger.



Once larvae have reached this final pediveliger stage they are capable of actively searching for an attachment site. At this stage they are called “eyed larvae” because of a distinctive black spot that can be observed under a microscope. When they have found a suitable attachment site, they undergo metamorphosis by cementing themselves in place and rearranging their internal body organs for their future non-mobile life. Metamorphosis marks the end of the larval phase and the beginning of the adult phase. For more information on oyster biology

consult Kennedy et al (1996) or Galtsoff (1964).



Critical to remote setting is the acquisition of highly competent,

eyed oyster larvae from a hatchery. Competence in oyster larvae is a measure of how ready an oyster larva is to undergo metamorphosis (i.e. the more competent a larva is, the closer it is to metamorphosis). Highly competent larvae are often referred to as “hot” meaning that they are very near metamorphosis. A large proportion of remote setting success is directly related to larval competence, and it is therefore important to work with a hatchery capable of consistently providing “hot”, ready to set, eyed larvae.

Setting

Receiving Larvae- Once the aged and cleaned shell is in the tank, the prepared tank has been filled and left static for 24 hours, it is time to receive larvae. Purchase enough larvae to put 100 larvae in the tank for every shell in the tank. For example, a set of 300 bushels (given 700 shells per bushel) requires 21 million eyed larvae. If larvae are picked up from the hatchery, bring a cold cooler to transport them. If receiving larvae by mail or courier expect to receive larvae from the hatchery in a cooler. Larvae will be packaged in a screen or coffee filter, wrapped with moist paper towels, and inside a plastic bag or container to prevent them from drying out. If the larvae will not be set immediately, place them in a refrigerator until ready for setting. Again, do not delay setting for more than a day. If larvae were shipped, check the temperature of the larvae when they arrive. If they are not cool to the touch, their health may have been compromised during transport. There should be a

collection date written on the bag containing the larvae. This date is the day the larvae were removed from culture and should be no longer than five days prior to receipt. Record the collection date, any batch-code that may be written on the bag and the quantity of larvae for your records.

As a method of quality control, the quantity of larvae received can be checked, if so desired, by weighing them. It is best to do this at the time of setting since larvae will be handled and unwrapped then anyway. To get an accurate weight, the paper towels should first be removed and any excess water wicked away from the larval ball. It is not necessary to take the larvae out of the screen or coffee filter. Diploid oyster larvae should weigh approximately 10-11 grams per million. Triploid oyster larvae should weigh approximately 13-14 grams per million. These weights are subject to a lot of variation depending on conditions during which larvae were grown and are only meant to be a rough estimate. By keeping these sorts of records,

over time a setter will begin to recognize good quality larvae.

Acclimating and Assessing

Larvae- Plan on about an hour of work to acclimate and set the larvae. A list of necessary items include:

- a notebook for record keeping
- a thermometer
- a five-gallon bucket
- a salinity measurement device
- a small cup
- microscope and scale (optional)

When ready to set, remove the larval package from the cooler and allow larvae to warm (still completely packaged) to ambient outdoor temperature (up to 30 minutes is fine) in a shaded, safe place where the larvae will not be knocked over, stepped on, etc.

While the larvae are warming adjust the aeration in the tank to a very gentle boil, record the temperature and salinity of the setting water and make note of any pertinent observations. By keeping

good records, a setter will be able to adjust their protocol to what works best for a particular site.

Fill the five gallon bucket with water from the setting tank. After larvae have acclimated outside (dry acclimation) of the cooler or refrigerator, gently remove the larval ball from the bag, remove the paper towels from around the screen or coffee filter, and then lower the screen or coffee filter into the bucket and gently rinse the larvae off the screen into the water (wet acclimation). The majority of the larvae will sink to the bottom - this is normal. Gently swirl the water to suspend the larvae in the water column for about 30 seconds. While the larvae are suspended in the water, dip a small clear cup into the water to remove a sample of larvae from the five gallon bucket. Larvae will be easier to observe in the cup.

Place the clear cup with larvae in a bright place where it can be easily viewed. After about a minute the majority of the larvae will sink to the bottom. Larvae may be visible actively swimming to the bottom. Considering the biology in the larval life-cycle larvae should be near the bottom of the water column searching for a place to set- therefore larvae at the bottom is good.

Allow the larvae 15 minutes to acclimate in the bucket and cup then observe the edges of the bottom of the cup. As larvae warm and become active, they should be swimming as much as a 1/4 inch up and down off the bottom. If you do not see this activity, allow the larvae to continue to acclimate.

Larvae may also begin stringing or clumping in the bucket and/or cup. As larvae prepare to set mucous

is secreted from glands at the base of their foot which allow them to crawl along the bottom using their foot similar to a snail. Because larvae are at such a high density however,

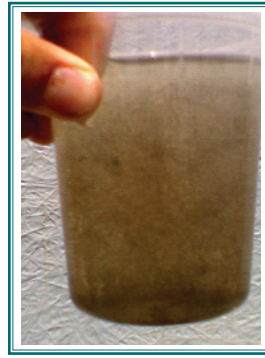

causes the larvae to stick together forming clumps or strings of larvae (photo-above). Gently swirl the water in the bucket or cup and watch for clumps or strings of larvae. If clumping is not observed, allow the larvae to continue to acclimate. Larvae can be left in the bucket for up to 30 minutes.

A dissecting microscope can be helpful to assess larvae during the acclimating period. A dissecting scope can usually be purchased for between \$200 and \$600. If using a microscope set it up in a place out of the wind, or simply set the scope up inside. Any breeze that rocks the larvae on the slide will keep larvae from actively swimming. Larval health can be better assessed by observing larvae under a microscope (photo below) than in the cup or bucket. If

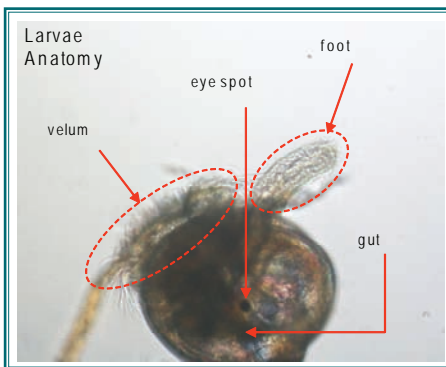

larvae are close to setting, the vast majority of larvae viewed under the scope should have a dark black dot

or “eye spot” and there should be some larvae crawling around using their foot. Larvae should have a dark black or brown gut with the rest of the tissue appearing light brown.

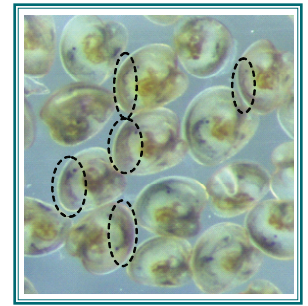

Dark red coloration of the gill likely signifies a bacterial infection which is common in larval culture (photo-above). The darker and larger the red area, the more intense the infection. Although this is not desired, good sets have occurred after observation of light to moderate infections. The affect of infection on post-set survival, however, is not known. Larvae that appear to have a bubble inside (photo-below) the shell or are clear with no coloration are dead. It is possible to have some dead larvae in any batch, but it should be a very small proportion. Not all of the larvae will appear active. Good sets have still occurred after observation of less than 25% appearing active

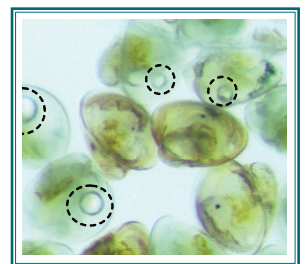

more than 25% should be active. It is important to keep records of these observations for every set. This provides a setting location with references for information on potential issues to discuss with the hatchery supplier.

If larvae arrive in one batch, but need to be set in two tanks, the best time to split the larvae is during the wet acclimation. To split larvae during wet acclimation, place a

known volume of water in a five gallon bucket. Have another two buckets available. Graduated buckets (those marked in liters or quarts) work best and are readily available from any home store. For example, for 20 million larvae which are going into two equally sized tanks, put eight liters of water in the acclimation bucket and begin wet acclimation of the larvae. To split the 20 million larvae into two portions of ten, simply pour 4 liters into one bucket and 4 liters into the other. To do this accurately, it is imperative to simultaneously



swirl (with a perforated plunger or large slotted spoon) and pour the water so that larvae are evenly mixed in the water column while pouring. Also, to ensure the split is even a split, pour a little into one bucket, then a little into the other, constantly alternating between

the two until all the water from the original bucket is gone. A little practice using water without larvae is warranted as larvae are the highest expense of the setting operation.

When larvae are ready (i.e. vertical swimming in the cup, stringing in the bucket, active under the scope) and all observations have been recorded in a notebook, it is time to set the larvae. The idea in setting larvae is to distribute them as evenly around the tank as possible. The current preferred method in Virginia is to broadcast

larvae via a small cup (photo left). Swirl the water in the bucket to suspend the larvae evenly in the bucket, dip the cup into the bucket to collect a cup full of larvae, and then toss the water from the cup into the tank. Each time you dip the cup back into the bucket, swirl it a few times to keep the larvae suspended evenly in the water. If larvae become too dense in the bucket, simply add more tank water to the bucket. The water – larvae mixture should always look brown, never black. This helps to more evenly distribute the larvae. The technique is very similar to

spreading grass seed or chicken feed.

Once the larvae are in the tank, they are given three days to set. During those three days the tank is left static (i.e. no water going in or out) so that larvae are not flushed from the tank. After the three days, the newly set spat have likely depleted any food in the tank and their waste has been slowly increasing levels of ammonia and nitrite which are harmful to larvae and spat in high concentrations. Therefore after three days, pumps are turned back on to establish flow through (i.e. unfiltered water flowing into the tanks and exiting through the overflow standpipe) to remove waste products from the tank and bring fresh food. Consequently, any larvae that have not set within those three days will eventually be flushed from the system. This is the reason highly competent larvae are so important to successful remote setting, as any not set at the time flow-through is established will be lost. After flow through is established, spat are allowed to feed and grow for approximately seven days to increase their size before planting

.See Appendix 3 for a summary of setting protocol.

Planting

Spat-on-shell produced in Virginia has to date, typically been planted around ten days after setting. When bags are used for shell containment, planting is done by transferring the bags (approximately ½ bushel each) from the setting tank to the planting vessel. Nearly any work-vessel is capable of doing this. Large skiffs can generally carry 75 bushels or

less whereas a typical Chesapeake deadrise is capable of carrying around 200 bushels. Once bags are loaded onto the boat, they are taken to the planting ground and bags are cut (photo-right) open, broadcasting the shells from a moving boat directly on the bottom. Do not throw the bags overboard as they are not biodegradable. When planting carry a trash can and bring the bags back for proper disposal on shore.



If cages are used for containment, much less labor is involved in planting, though heavy equipment is then necessary. The cages would be removed from the tanks by a crane or forklift and dumped onto the deck of the planting boat. The planting boat must then be able to handle planting of this loose shell. An open deck boat with a high volume (low pressure) pump can be used to float, not blast, seed off the boat, or an open deck modified with a conveyor and spreader may be used (photo- Bevans Oyster Company)

Knowing the average number of spat per shell at planting also makes for an easy way to track spat-on-shell during growout. For example, if there were 10 spat per shell when planted and later that year sampling several clumps of oysters yields only an average of 5 oysters per shell, then approximately 50% have survived.

Determining Setting Rate

The best time to assess the success of the set is during planting. A proposed method for determining setting rate is outlined below:

1. Calculate the mean number shells in each of 10 unset shell bags (this should be done at least once a season).
2. At the time of spat-on-shell planting, collect 100 shells from each tank taking no more than 5 shells from one bag- collecting shells from different areas and depths in the tank.
3. Calculate the mean number of spat per shell for each tank.
4. Calculate the total number of spat produced in each tank independently by multiplying the number of shells in the tank (derived using the calculation from number 1) by the mean number of spat per shell.
5. Calculate setting rate for each tank independently by dividing the number of spat produced in each tank by the number of larvae used in each tank.
6. To obtain an overall setting rate for a single batch of larvae split into multiple tanks, simply average the individual setting rates for each tank.

If done with relative frequency, this simple assessment technique could help to determine how much

product you have on the bottom at any one time.



Growout

Data suggests that disease resistant diploid spat-on-shell could reach market size in 30 months with a harvest yield of 2:1 (2 bushels of market oysters for every 1 bushel of planted spat-on-shell (Congrove 2009). It is possible that disease resistant triploid spat-on-shell

could reach market size in 18 months with a harvest yield of 3:1 (Southworth et al in prep). Note that because these oysters are cultured, they can be harvested smaller than the legal size of three inches if so desired.

Assuming that spat-on-shell have been placed on good oyster bottom,

the major risk to the growing oysters will be the cownose ray. Spat-on-shell grow out in clusters that are somewhat of a deterrent to ray predation. It is advisable to not break the oyster clusters apart until final harvest to maintain as much predator protection as possible.

Facility Costs

Facility set up costs range from \$3,000 to \$14,000 dollars for a capacity of 300 bushels per set. The table to the left displays a range of costs for a facility of this size. Note that shell handling equipment is excluded from this table and on small scales can be done by hand or at low cost via daily loader rentals. An operator may not need all of these items for the first year or two, or some items could be shared with other facilities.

Item	Cost
Tank(s)	\$1,000 - \$7,000
Pump	\$600 - 800
Blower	\$750 - \$1,000
Heater(s)	\$0 - \$3,000
Plumbing	~\$300
Shell Washer	~\$500 - \$2000

Operating costs can be broken down into materials, labor, and utilities. The below to the right displays per bushel estimates of these costs. Total cost of production is \$19.40 - \$21.80 depending on whether or not

heaters are used. Excluding labor, the cost is \$15.80 - \$18.20 per bushel.

Material cost estimates are based on prices of \$200 per million for eyed larvae and \$50 for a thousand foot roll of bag material.

Note that this estimate is for the production and planting of spat-on-shell only and does not include any associated harvest costs. Also not included are estimate of associated cost for plant site preparation should any be necessary.

Data collected on disease resistant, diploid spat-on-shell planted in 2006 suggests that a yield of 2:1 (two bushels of harvested oysters for every one bushel of spat-on-shell planted) is realistic. A yield of 2:1 effectively cuts in half the realized per bushel production cost, reducing it to \$9.70 to \$10.90 per harvested bushel. If harvest costs are \$12 per bushel, profit on a \$35 bushel of oysters is \$12.10 - \$13.30.

Setting Costs per Bushel

Materials	\$15.40	
shell	\$1.00	
bag	\$0.40	
larvae	\$14.00	
Utility	\$2.80	
electricity		
with heater	\$2.63	
without heater	\$0.23	
fuel	\$0.17	
		hours
Labor (\$8/hr)	\$3.60	0.45
baqqing	\$2.56	0.32
tank loading	\$0.24	0.03
tank unloading	\$0.32	0.04
planting	\$0.48	0.06
Total cost per bu.		
	\$19.40 - \$21.80	

A customizable enterprise budget for remote setting (Congrove Thesis) will be available January 2009 from the Virginia Institute of Marine Science.

Summary

Remote culture has the potential to return the Virginia oyster industry to a level of privatization and self-sufficiency not seen since the 1960s. Prior to the 1960s the majority of oyster landed in Virginia came from private ground. Since the 1960s,' disease related mortalities and the risk associated with transplanting oysters drastically reduced this practice. Without private oyster production,

Virginia had only a small fraction of its previous oyster landings and processors were quickly forced to retrieve more and more product from out of state.

Consider that the Virginia clam aquaculture industry sold 211 million clams last year. If you were to translate that into bushels of oysters it would be over 600,000 bushels of oysters (assuming 350 oysters per bushel). Annual processing demand in Virginia

is typically between 500,000 and 600,000 bushels. It is not hard to imagine what is possible with aquaculture, and that a self-sufficient oyster industry is not out of reach.

Remote setting technology is simple and relatively inexpensive and is capable of large scale oyster production using little labor. With patience and diligence sound returns can be made on the required investments.

References

- Congrove, MS. 2009. A Bio-Economic Feasibility Model for Remote Setting: Potential for Oyster Aquaculture in Virginia. Masters Thesis. Virginia Institute of Marine Science.
- Galtsoff, PS. 1964. The American oyster, *Crassostrea virginica* (Gmelin). Fishery Bulletin. US Fish and Wildlife Service. U. S. 64:1480.
- Kennedy, VS, RIE Newell, AF Eble. 1996. The Eastern Oyster *Crassostrea virginica*. A Maryland Sea Grant Book, College Park, Maryland. 734p.
- Southworth, M, AT Legget, AJ Erskine, R Mann. IN PREP. Evaluation of triploid *Crassostrea virginica* for on bottom culture in Chesapeake Bay. Virginia Institute of Marine Science.
-

Appendix 1 - Facility Setup Guidelines

1. **Tank Selection** – shallow, rectangular or circular. Size tank to allow for 2,000 gal capacity per 100 bushel of shell to be set (see p. 4-6 for more).
2. **Air Lines** – PVC, any arrangement that promotes circulation. 1/16” or 1/8” spaced 6” or 12” respectively (see p. 4-6 for more).
3. **Water Pump** – size pump to allow for at least 50gpm per 100 bushels of spat-on-shell in the setting system (see p. 7 for more).
4. **Air Blower** – regenerative blower is best. Size pump for at least ¼ hp per 1000 gal of tank capacity. Depth must be no greater than 4’ (see p. 7 for more).
5. **Heater** – immersion heater is best. 4000 watts will raise 1000 gal 5°C (~10°F). This should be an adequate working range for setting in May and September. Therefore a 3,000 gal tank would require a 12,000 watt heater (see p. 7 for more).

Appendix 2 – Vendor List

Equipment

Dolphin Fiberglass Tanks, Inc.

1-305-247-8750

www.aquaculturetanks.com

- round and square fiberglass tanks

Aquatic Ecosystems, Inc.

1-877-347-4788

www.aquaticeco.com

- pumps, blowers, heaters, and filter bags
- misc. aquaculture supplies
- technical support

Conwed Plastics, Inc.

1-800-368-3610

www.conwedplastics.com

- shell bag material
“NRC-370-013”

Eyed Larvae

Middle Peninsula Aquaculture

Mathews, Virginia

1-804-725-0159

J.C. Walker Brothers

Willis Wharf, Virginia (Eastern Shore)

1-757-442-6000

Oyster Seed Holdings

Gwynn’s Island, Virginia

804-725-3046

Appendix 3 - Setting Protocol (see p. 7-13 for details)

1. Prior to season

- Check pumps, blowers and any other equipment
- Load first batch of cleaned and containerized shell into setting tanks

2. Tank set-up

- Plan to rinse, then fill tanks with filtered water on the 2nd half of an incoming high tide approximately
24 hours before larvae arrive
- Remember to turn on aeration before filling
- If water temperature is less than 25°C, turn on heaters after tanks are full if necessary

3. Larval acclimation and setting

- Dry Acclimation: place larvae, still packaged, outside of cooler (15-30 minutes)
- Wet Acclimation: carefully un-package larvae and place in 5 gallon bucket filled with setting tank water
(15-30 minutes)
- Setting: When larvae are active (stringing in bucket and/or cup, swimming in cup and/or on microscope)
distribute them evenly into tank

4. Tank - static

- Ensure aeration is on and heater thermostat is set to 27°C or 28°C (if in use).
- Allow tank to remain static for three days

5. Tank – flow-through

- After three days, turn water pumps back on (do not filter water) and allow water to exit tank through
stand pipe to feed the newly set spat
- Allow heaters to run another half day, then shut down
- Maintain flow-through for another 7 days or so until spat reach a couple millimeters in size

6. Plant

Appendix 4 - Setting Optimization

Optimizing the remote setting process for a particular site can have significant impacts on profitability of a remote culture operation. Every effort should be made to obtain the highest setting



rate possible. Consider a setting rate of 10%, 7.5%, and 5%. The cost to produce and plant 1000 spat-on-shell seed at each of these setting rates respectively is \$2.77 - \$3.11, \$3.70 - \$4.15, and \$5.54 - \$6.23 respectively, excluding site prep. Increasing remote setting rate by just 2.5% translates to a savings of more than a dollar per thousand spat-on-shell seed!

A good starting point is to follow the setting protocols outlined in this manual (and easily referenced in the setting protocol – Appendix 2), but also do not hesitate to adapt protocol to a specific site after experience is gained setting there. Good record keeping will help form optimal, site-specific setting protocols.

Below are the results of several experiments run in the summer of 2008 to test specific parameters or problems identified as important in the remote setting process. These experiments were conducted in a 1:3000 scale remote setting system capable of static and flow-through conditions to mimic as closely as possible a typical setting facility in Virginia (photo above). Experimental tanks had a filled volume of three liters and were used to set 24 shells. During any experiment, each experimental treatment was performed in three identical replicate tanks. The result reported is the mean of these three replicates. Water was filtered to 50 μ m prior to setting and typical salinity and temperature was 20ppt and 28°C. The setting apparatus is shown in the picture to the right. Experiments were conducted at Gloucester Point, VA in cooperation with the Virginia Institute of Marine Science (VIMS)

Galvanized Containment Cages

The use of galvanized cages was investigated by a setting facility as a means of mechanized containment of oyster shell for setting. Cages used were those often used handling shell stock at processing facilities and in shipping containers. After an unsuccessful set using these cages, it was hypothesized that perhaps the galvanized cages were releasing substances toxic to the setting larvae.

To test this hypothesis a setting experiment was run using two treatments (three tanks for each treatment). Treatment A had oyster shell only whereas treatment B had oyster shell and a piece of the galvanized cage. If treatment A set significantly better than treatment B, then the cage material was to blame for the poor set. Mean set rate of treatment A was 7.5%, but only 0.44% for treatment B. We can therefore conclude that these cages are causing the poor setting and should not be used.

Duration Static

The optimal number of days to leave a setting tank static was investigated. Remote setting tanks are static (no water in or out) first to allow larvae a chance to set, then turned to flow-through (water running in and out) to allow set spat to feed. Tanks should be left static long enough so that the maximum number of larvae set, but not long enough to cause mortality of spat from starvation or waste toxicity.

To determine this duration empirically a series of four setting experiments were run. Treatments were defined by the number of days the tank was left static. The treatment that had the highest resulting mean setting rate would determine the optimal number of days to leave a tank static. A

table displaying the results of this experiment is shown to the right. The table displays the mean setting rate of each treatment for each of the four experiments run. Highlighted

Days Static	Exp. 1	Exp. 2	Exp. 3	Exp. 4
1	3.37%			
2	6.03%	23.39%	3.32%	8.33%
3	8.44%	20.79%	5.11%	13.93%
4		16.73%		
5		15.24%		

setting rates are those that were the highest in each experiment. Leaving tanks static for three days resulted in the highest setting rate for three out of the four experiments. The outlier, experiment two, was characterized by very high setting rate, presumably due to very hot (ready to set) larvae. It may be that when larvae are very ready to set, three days static is not necessary. Nonetheless, a good starting point for your operation is to leave tanks static for three days and fine tune it from there to what works best for your site and given the larvae you receive.

Feeding

Some remote setting literature suggests that setting tanks should be supplemented with cultured or “instant” algae during the static phase the setting process. It certainly makes sense that this might negate any starvation effects resulting from the static phase.

An experiment was run to determine whether feeding during the static phase resulted in a higher setting rate. Two treatments were used, one where no algae was added (treatment

A), and one where live cultured algae was added at a density of 100,000 cells per ml once per day for the three days static period (treatment B). The mean setting rate of treatment A was 19.48% and 17.39% for treatment B. Feeding during the static phase did not increase remote setting rate. Given this result, it is not necessary to feed during the static phase, particularly given that the annual cost of algae for producing 2400 bushels is approximately \$1,500.

Note that this experiment was run during summer and water used was only filtered to 50µm. It is possible that algae supplementation may be beneficial early or late in the season when algae are not plentiful in ambient water or if water is more finely filtered.

Water Filtration

The level of water filtration was investigated to determine whether more finely filtered water would result in higher setting rates. Four treatments were used of various levels of filtration including: unfiltered water, mechanical filtration to 50µm, mechanical filtration to 5µm, and hatchery filtered water comprised of mechanical filtration to 5µm combined with chemical and UV filtration.

The results of this experiment are displayed in the figure below. The highest mean setting rate was associated with setting done in water filtered mechanically to 5µm. Typically, in Virginia, water used for remote setting is mechanically filtered to 75µm or 50µm. Given these results, it may be advantageous to filter water further to a level similar to 5µm.

Note that filtration this fine will likely remove a large proportion of the algae in the ambient water and for that reason, it may be necessary to supplement algae if filtering to this level.

